

**ARMADA ARGENTINA**

**DIRECCIÓN GENERAL DE INTENDENCIA DE LA  
ARMADA**

**DIRECCIÓN DE ABASTECIMIENTOS DE LA ARMADA  
DEPARTAMENTO INDUMENTARIA**

**MANUAL TECNICO**

**ARA-INDUMENTARIA 001**

**ORIENTACION PARA DETERMINAR EL TALLE DEL USUARIO**

## INDICE

ORIENTACION PARA EL USUARIO EN LA ELECCION DEL TALLE.....	Paginas 3 a 11
AMBO NAVAL.....	Paginas 12 a 18
AMBO SANIDAD.....	Paginas 19
BLUSAS MARINERAS PANTALON , FALDA Y CUELLO MARINERO.....	Paginas 20 a 26
BUZOS.....	Paginas 27
CAMISAS.....	Paginas 28 a 32
CAMISETAS.....	Paginas 33 a 34
CAMPERA.....	Paginas 35
CAPOTE.....	Paginas 36 a 39
CHAQUETILLAS .IM.....	Paginas 40 a 44
CONJUNTOS.....	Paginas 45 a 61
GABAN.....	Paginas 62 a 63
MAMELUCOS.....	Paginas 64 a 66
SWEATER.....	Paginas 67
GORRAS.....	Paginas 68
JARDINERO PARA EMBARAZADAS.....	Paginas 69
MEDIAS.....	Paginas 70
PANTALON CORTO PARA DEPORTE.....	Paginas 71

## ORIENTACION PARA EL USUARIO EN LA ELECCION DEL TALLE

AQUÍ ENCONTRARA LA GUÍA NECESARIA PARA DETERMINAR SU TALLE Y COMO IDENTIFICAR EL TALLE QUE LE CORRESPONDE.

### CONSEJOS PARA ORIENTACIÓN:

- PARA DETERMINAR SU TALLE NO GUIARSE POR EL TALLE DE PRENDAS DE OTRO ORIGEN YA QUE ESTAS PUEDEN VARIAR DE UNA MARCA A OTRA
- SE DEBERÁ DEFINIR EL TALLE EN FUNCIÓN DEL TIPO DE PRENDA.
- EN LA CASO DE LOS CONJUNTOS LOS TALLES SE DETERMINARÁN POR LOS MEDIDAS DE LA PRENDA SUPERIOR
- LOS TALLES DE LOS CONJUNTOS NO VARÍAN ENTRE LA PRENDA SUPERIOR Y LA PRENDA INFERIOR.
- TOMANDO UNA PRENDA IGUAL O SIMILAR A LA QUE NECESITO ADQUIRIR EXTENDERLA SOBRE UNA SUPERFICIE PLANA Y CON UNA CINTA MÉTRICA MEDIRLA EN LOS PUNTOS QUE SE DETALLAN EN EL GRAFICO PARA ORIENTACIÓN
- CON LAS MEDIDAS RESULTANTES BUSCAR EN LA TABLA DONDE SE UBICAN DE FORMA APROXIMADA EL TALLE O NÚMERO QUE LE CORRESPONDE AL USUARIO
- SEGÚN EL TIPO DE PRENDA LOS TALLES PUEDEN SER POR LETRA POR NÚMERO O TALLE ÚNICO.
- EN LOS CASOS QUE EL TALLE CUENTE CON LA OPCIÓN CORTO MEDIANO O LARGO SE DETERMINARA POR EL LARGO DE LA PRENDA EN LAS PARTES SUPERIORES O LARGO DE PIERNA EN PARTES INFERIORES.

## INDICACIONES DE MEDIDAS GENERALES

### EQUIVALENCIAS DE TALLES

TALLE CON LETRA	TALLE TRADICIONAL	TALLE NUMERICO
XS	34	1
XS	36	2
S	38	3
S	40	4
M	42	5
M	44	6
L	46	7
L	48	8
XL	50	9
XL	52	10
XXL	54	11
XXL	56	12
XXXL	58	13
XXXL	60	14

## TOMA DE MEDIDAS CAMISAS

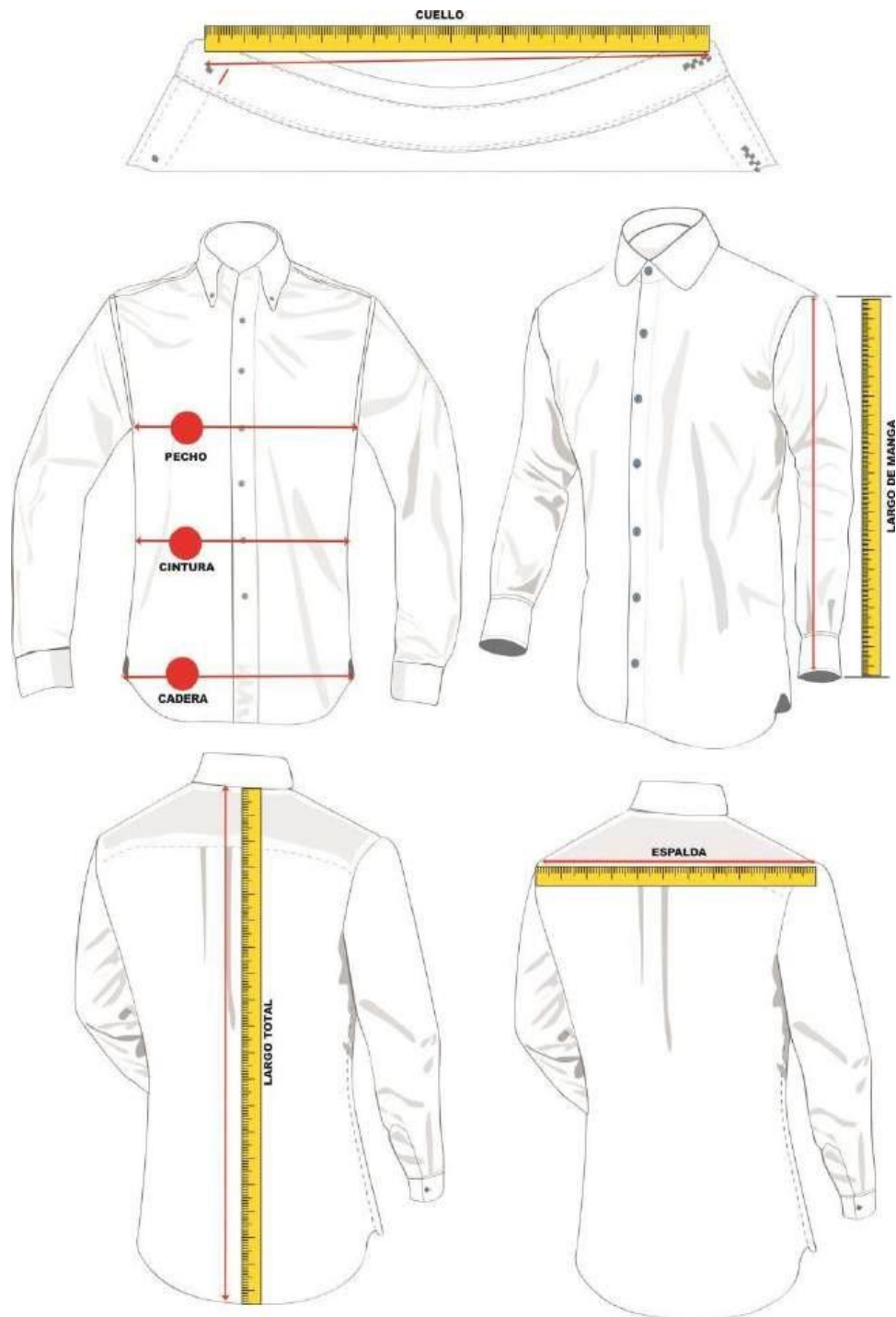

## TOMA DE MEDIDAS SACOS

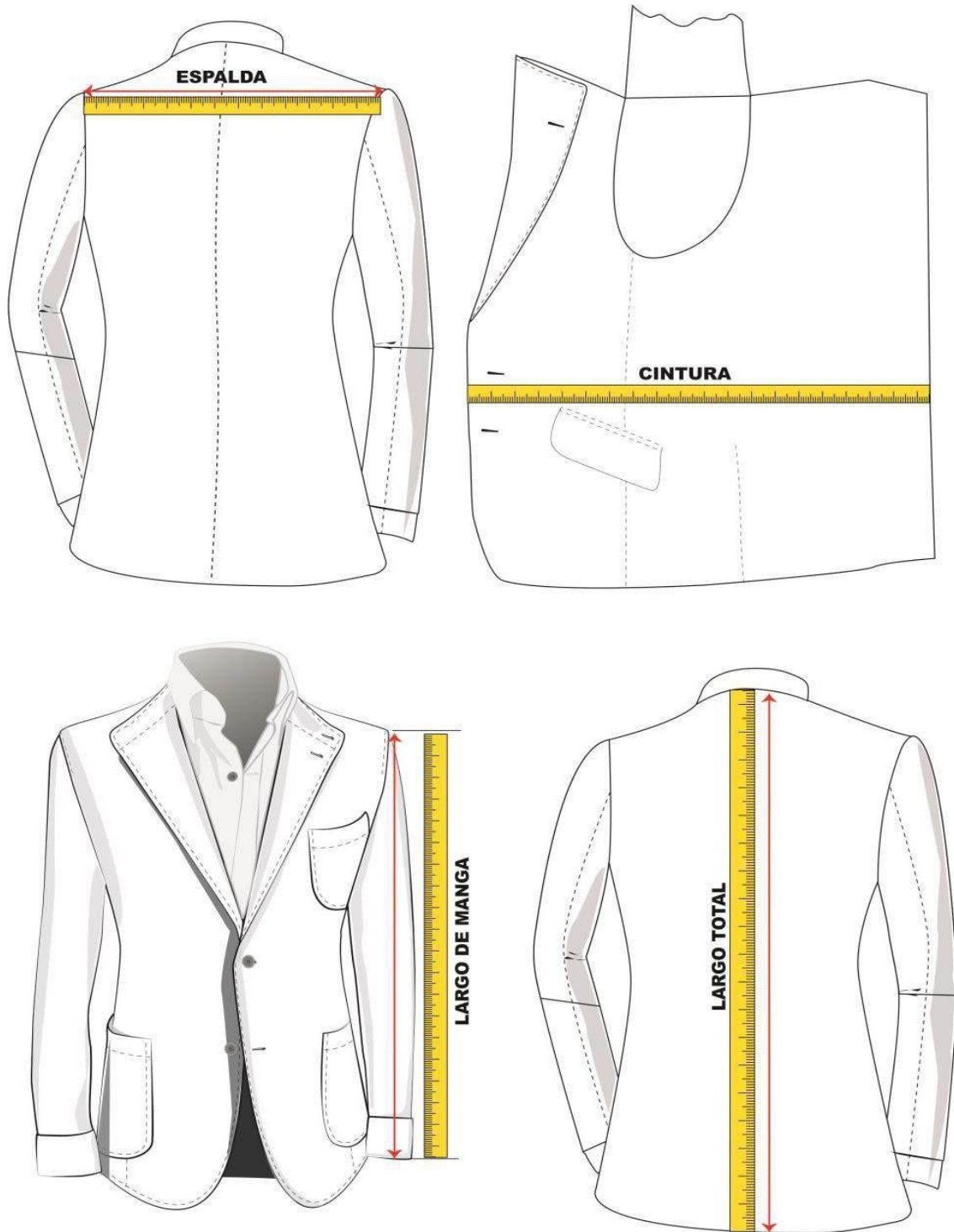

## TOMA DE MEDIDAS PANTALONES

**CINTURA**

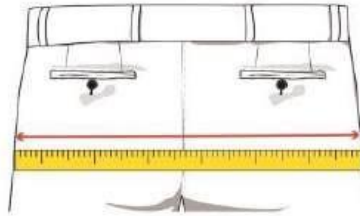
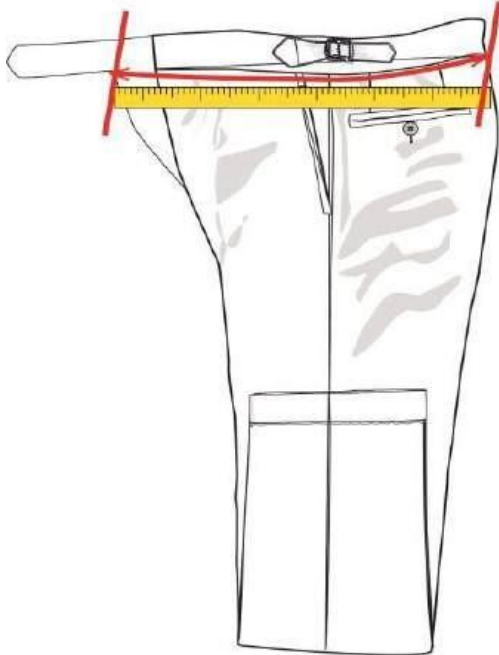

**CADERA**

**LARGO TOTAL**

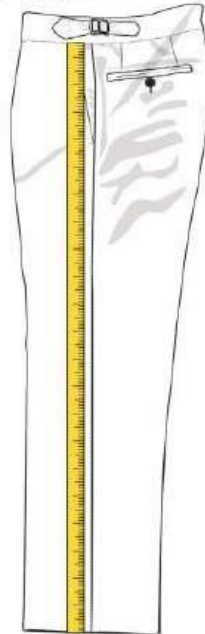

**ENTREPIERNA**

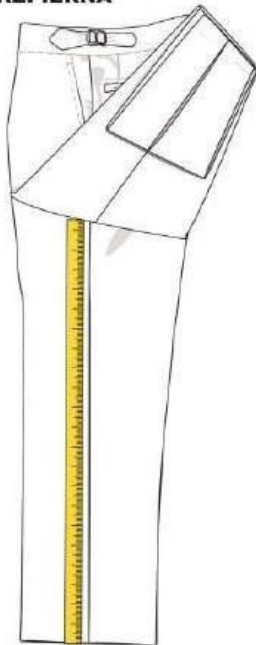

## INDICACIONES DE MEDIDAS GENERALES

### COMO DEFINIR LA MEDIDA PARA DETERMINAR EL NÚMERO

**OPCION 1:** MEDIR EL PIE SEGÚN LAS SIGUIENTES INDICACIONES (EN ACONSEJABLE MEDIRLO AL FINAL DEL DIA YA QUE EL PIE PUEDE SUFIR MODIFICACIONES A LO LARGO DEL DIA)

- 1-PARARSE DE PIE CONTRA LA PARED SOBRE UNA HOJA DE PAEL
- 2-COLOCAR BIEN LAS PLANTAS DE LOS PIES CONTRA LA PARED SOBRE LA HOJA
- 3-MARCA EL LÍMITE DEL DEDO GORDO SEGÚN EL GRAFICO
- 4-CON ESA MEDIDA SE DETERMINA LA MEDIDA DE LA PLANTILLA

**OPCION 2:** MEDIR LA PLANTILLA DEL CALZADO HABITUAL

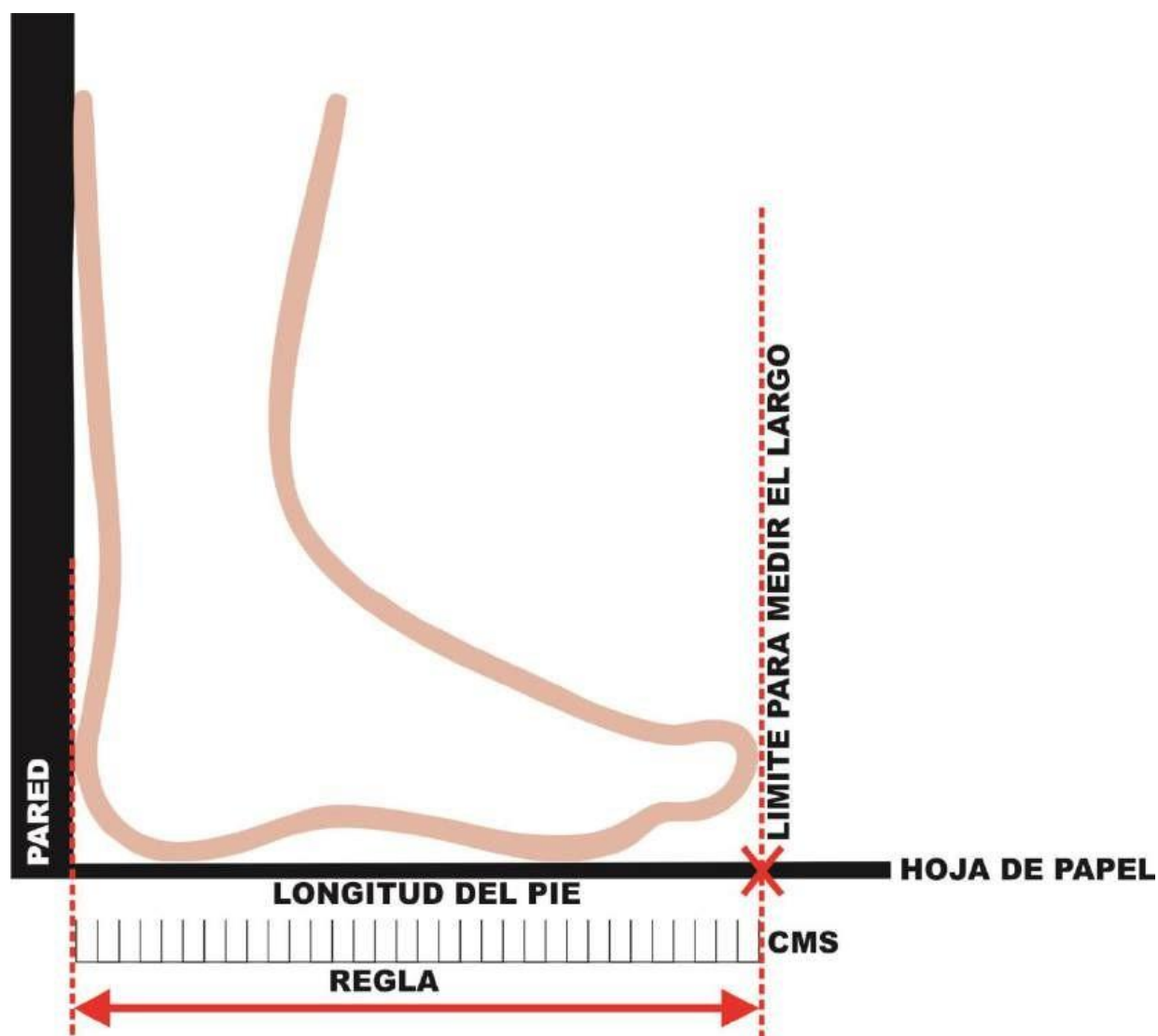

## COMO DEFINIR LA MEDIDA DE LA PLANTILLA

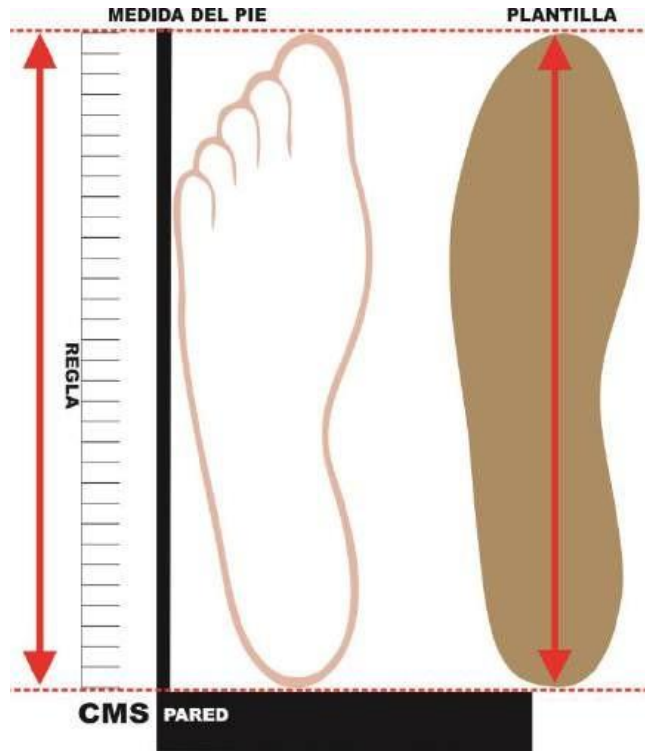

## COMO DEFINIR EL NÚMERO DEL CALZADO

LONGITUD DEL PIE + MARGEN ADICIONAL = NUMERO DEL ZAPATO. EL MARGEN ADICIONAL PUEDE VARIAR SEGÚN EL USUARIO EN FUNCION DE LA COMODIDAD PERSONAL.

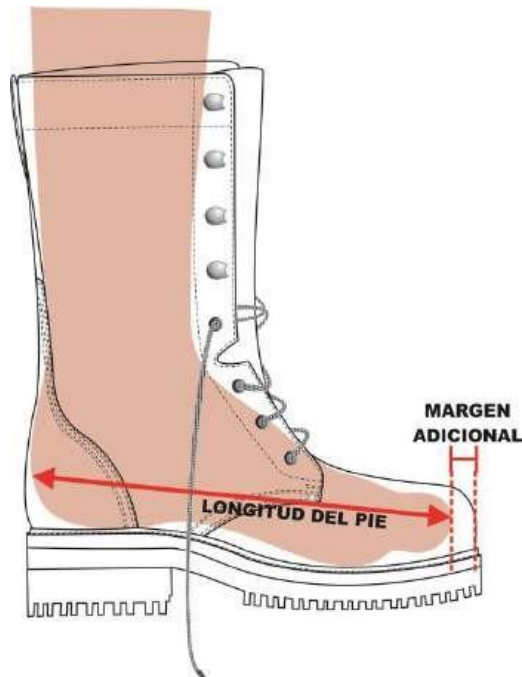

## TABLA DE MEDIDAS ZAPATO MASCULINO BLANCO Y NEGRO

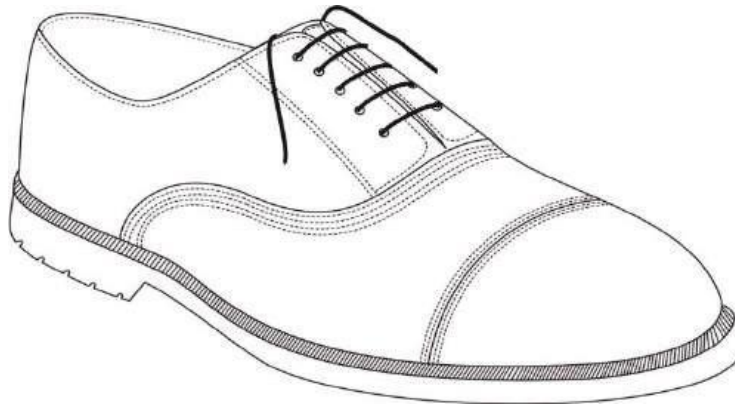

NOTA: PARA ESTABLECER LA NUMERACIÓN DEL CALZADO ES ACONSEJABLE QUE SI LA MEDIDA ESTA ENTRE 2 NUMEROS ELEGIR EL NUMERO MAYOR

<b>NUMERO</b>	<b>MEDIDA DE LA PLANTILLA</b>	<b>TOLERANCIA</b>
<b>36</b>	<b>24,8</b>	<b>0.3</b>
<b>37</b>	<b>25,2</b>	<b>0.3</b>
<b>38</b>	<b>25,7</b>	<b>0.3</b>
<b>39</b>	<b>25,9</b>	<b>0.3</b>
<b>40</b>	<b>26,1</b>	<b>0.3</b>
<b>41</b>	<b>26,9</b>	<b>0.3</b>
<b>42</b>	<b>27,7</b>	<b>0.3</b>
<b>43</b>	<b>28,4</b>	<b>0.3</b>
<b>44</b>	<b>29,1</b>	<b>0.3</b>
<b>45</b>	<b>30,01</b>	<b>0.3</b>
<b>46</b>	<b>30,8</b>	<b>0.3</b>
<b>47</b>	<b>40</b>	<b>0.3</b>

## TABLA DE MEDIDAS ZAPATO FEMENINO BLANCO Y NEGRO

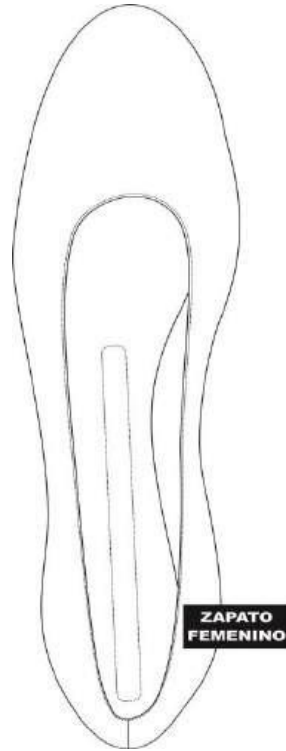

<b>NUMERO</b>	<b>MEDIDA DE LA PLANTILLA</b>	<b>TOLERANCIA</b>
<b>34</b>	<b>23,0</b>	<b>0.3</b>
<b>35</b>	<b>23,6</b>	<b>0.3</b>
<b>36</b>	<b>24,6</b>	<b>0.3</b>
<b>37</b>	<b>25,2</b>	<b>0.3</b>
<b>38</b>	<b>25,6</b>	<b>0.3</b>
<b>39</b>	<b>26,3</b>	<b>0.3</b>
<b>40</b>	<b>27,0</b>	<b>0.3</b>
<b>41</b>	<b>28,0</b>	<b>0.3</b>
<b>42</b>	<b>28,5</b>	<b>0.3</b>
<b>43</b>	<b>29,5</b>	<b>0.3</b>

## TABLA DE MEDIDAS BOTAS UCA/UCAN/NAVAL/DE VUELO/BOTIN

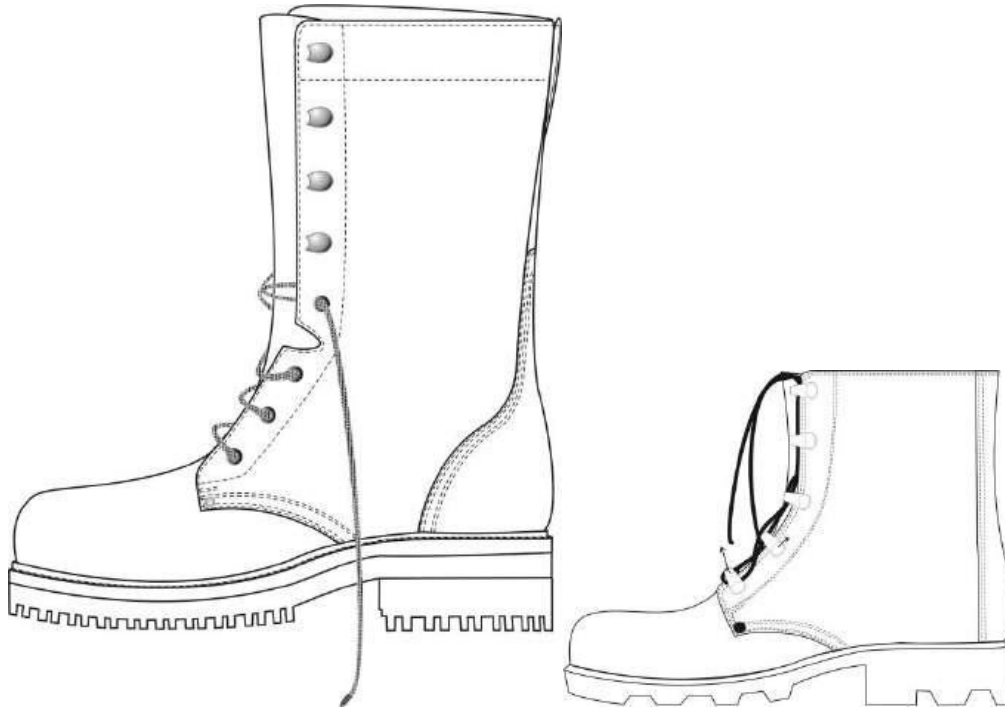

NUMERO	MEDIDA DE LA PLANTILLA	TOLERANCIA
<b>36</b>	<b>24,5</b>	<b>0.3</b>
<b>37</b>	<b>25,0</b>	<b>0.3</b>
<b>38</b>	<b>25,5</b>	<b>0.3</b>
<b>39</b>	<b>26,4</b>	<b>0.3</b>
<b>40</b>	<b>26,6</b>	<b>0.3</b>
<b>41</b>	<b>27,4</b>	<b>0.3</b>
<b>42</b>	<b>28,0</b>	<b>0.3</b>
<b>43</b>	<b>28,8</b>	<b>0.3</b>
<b>44</b>	<b>29,3</b>	<b>0.3</b>
<b>45</b>	<b>29,9</b>	<b>0.3</b>
<b>46</b>	<b>30,7</b>	<b>0.3</b>
<b>47</b>	<b>31,0</b>	<b>0.3</b>

# AMBO NAVAL

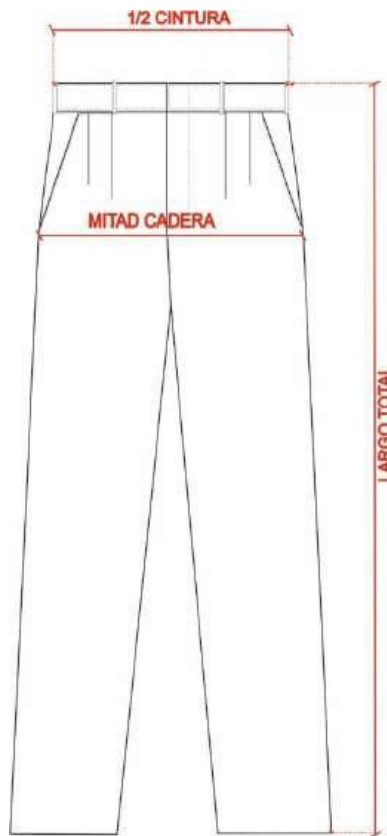
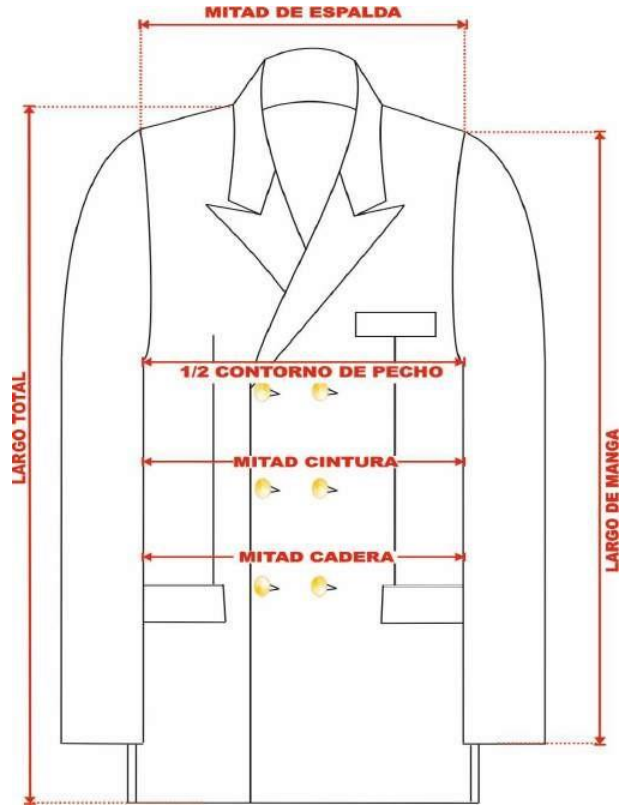

**SACO**

<b>TALLE</b>	<b>LARGO TOTAL</b>	<b>MITAD ESPALDA</b>	<b>LARGO MANGA</b>	<b>MITAD CINTURA</b>	<b>MITAD CADERA</b>	<b>½ CONTORNO DE PECHO</b>
<b>40 C</b>	<b>72</b>	<b>18.5</b>	<b>60</b>	<b>36</b>	<b>44</b>	<b>45</b>
<b>40 M</b>	<b>78</b>	<b>18.5</b>	<b>64</b>	<b>36</b>	<b>44</b>	<b>45</b>
<b>40 L</b>	<b>82</b>	<b>18.5</b>	<b>67</b>	<b>36</b>	<b>44</b>	<b>45</b>
<b>42 C</b>	<b>72</b>	<b>19.5</b>	<b>60</b>	<b>38</b>	<b>46</b>	<b>47</b>
<b>42 M</b>	<b>78</b>	<b>19.5</b>	<b>64</b>	<b>38</b>	<b>46</b>	<b>47</b>
<b>42 L</b>	<b>82</b>	<b>19.5</b>	<b>67</b>	<b>38</b>	<b>46</b>	<b>47</b>
<b>44 C</b>	<b>72</b>	<b>20.5</b>	<b>60</b>	<b>40</b>	<b>48</b>	<b>49</b>
<b>44 M</b>	<b>78</b>	<b>20.5</b>	<b>64</b>	<b>40</b>	<b>48</b>	<b>49</b>
<b>44 L</b>	<b>82</b>	<b>20.5</b>	<b>67</b>	<b>40</b>	<b>48</b>	<b>49</b>
<b>46 C</b>	<b>72</b>	<b>21.5</b>	<b>60</b>	<b>42</b>	<b>50</b>	<b>51</b>
<b>46 M</b>	<b>78</b>	<b>21.5</b>	<b>64</b>	<b>42</b>	<b>50</b>	<b>51</b>
<b>46 L</b>	<b>82</b>	<b>21.5</b>	<b>67</b>	<b>42</b>	<b>50</b>	<b>51</b>
<b>48 C</b>	<b>72</b>	<b>22.5</b>	<b>60</b>	<b>44</b>	<b>52</b>	<b>53</b>
<b>48 M</b>	<b>78</b>	<b>22.5</b>	<b>64</b>	<b>44</b>	<b>52</b>	<b>53</b>
<b>48 L</b>	<b>82</b>	<b>22.5</b>	<b>67</b>	<b>44</b>	<b>52</b>	<b>53</b>
<b>50 C</b>	<b>72</b>	<b>23</b>	<b>60</b>	<b>46</b>	<b>54</b>	<b>55</b>
<b>50 M</b>	<b>78</b>	<b>23</b>	<b>64</b>	<b>46</b>	<b>54</b>	<b>55</b>
<b>50 L</b>	<b>82</b>	<b>23</b>	<b>67</b>	<b>46</b>	<b>54</b>	<b>55</b>
<b>52 C</b>	<b>72</b>	<b>23</b>	<b>60</b>	<b>48</b>	<b>56</b>	<b>57</b>
<b>52 M</b>	<b>78</b>	<b>23</b>	<b>64</b>	<b>48</b>	<b>56</b>	<b>57</b>
<b>52 L</b>	<b>82</b>	<b>23</b>	<b>67</b>	<b>48</b>	<b>56</b>	<b>57</b>
<b>54 C</b>	<b>72</b>	<b>23.5</b>	<b>60</b>	<b>50</b>	<b>58</b>	<b>59</b>

<b>54 M</b>	<b>78</b>	<b>23.5</b>	<b>64</b>	<b>50</b>	<b>58</b>	<b>59</b>
<b>54 L</b>	<b>82</b>	<b>23.5</b>	<b>67</b>	<b>50</b>	<b>58</b>	<b>59</b>
<b>56 C</b>	<b>72</b>	<b>24.5</b>	<b>60</b>	<b>52</b>	<b>60</b>	<b>61</b>
<b>56 M</b>	<b>78</b>	<b>24.5</b>	<b>64</b>	<b>52</b>	<b>60</b>	<b>61</b>
<b>56 L</b>	<b>82</b>	<b>24.5</b>	<b>67</b>	<b>52</b>	<b>60</b>	<b>61</b>
<b>58 C</b>	<b>72</b>	<b>25</b>	<b>60</b>	<b>54</b>	<b>62</b>	<b>63</b>
<b>58 M</b>	<b>78</b>	<b>25</b>	<b>64</b>	<b>54</b>	<b>62</b>	<b>63</b>
<b>58 L</b>	<b>82</b>	<b>25</b>	<b>67</b>	<b>54</b>	<b>62</b>	<b>63</b>
<b>60 C</b>	<b>72</b>	<b>26</b>	<b>60</b>	<b>56</b>	<b>64</b>	<b>65</b>
<b>60 M</b>	<b>78</b>	<b>26</b>	<b>64</b>	<b>56</b>	<b>64</b>	<b>65</b>
<b>60 L</b>	<b>82</b>	<b>26</b>	<b>67</b>	<b>56</b>	<b>64</b>	<b>65</b>

### **PANTALON**

<b>TALLE</b>		<b>LARGO TOTAL</b>	<b>MITAD CINTURA</b>
<b>40</b>	<b>C</b>	<b>97</b>	<b>36</b>
<b>40</b>	<b>M</b>	<b>101</b>	<b>36</b>
<b>40</b>	<b>L</b>	<b>107</b>	<b>36</b>
<b>42</b>	<b>C</b>	<b>97</b>	<b>38</b>
<b>42</b>	<b>M</b>	<b>101</b>	<b>38</b>
<b>42</b>	<b>L</b>	<b>107</b>	<b>38</b>
<b>44</b>	<b>C</b>	<b>97</b>	<b>40</b>
<b>44</b>	<b>M</b>	<b>101</b>	<b>40</b>
<b>44</b>	<b>L</b>	<b>107</b>	<b>40</b>
<b>46</b>	<b>C</b>	<b>97</b>	<b>42</b>
<b>46</b>	<b>M</b>	<b>101</b>	<b>42</b>
<b>46</b>	<b>L</b>	<b>107</b>	<b>42</b>

<b>48</b>	<b>C</b>	<b>97</b>	<b>44</b>
<b>48</b>	<b>M</b>	<b>103</b>	<b>44</b>
<b>48</b>	<b>L</b>	<b>108</b>	<b>44</b>
<b>50</b>	<b>C</b>	<b>97</b>	<b>46</b>
<b>50</b>	<b>M</b>	<b>103</b>	<b>46</b>
<b>50</b>	<b>L</b>	<b>108</b>	<b>46</b>
<b>52</b>	<b>C</b>	<b>99</b>	<b>49</b>
<b>52</b>	<b>M</b>	<b>104</b>	<b>49</b>
<b>52</b>	<b>L</b>	<b>109</b>	<b>49</b>
<b>54</b>	<b>C</b>	<b>99</b>	<b>52</b>
<b>54</b>	<b>M</b>	<b>104</b>	<b>52</b>
<b>54</b>	<b>L</b>	<b>109</b>	<b>52</b>
<b>56</b>	<b>C</b>	<b>100</b>	<b>54</b>
<b>56</b>	<b>M</b>	<b>105</b>	<b>54</b>
<b>56</b>	<b>L</b>	<b>110</b>	<b>54</b>
<b>58</b>	<b>C</b>	<b>100</b>	<b>56</b>
<b>58</b>	<b>M</b>	<b>105</b>	<b>56</b>
<b>58</b>	<b>L</b>	<b>110</b>	<b>56</b>
<b>60</b>	<b>C</b>	<b>103</b>	<b>58</b>
<b>60</b>	<b>M</b>	<b>107</b>	<b>58</b>
<b>60</b>	<b>L</b>	<b>113</b>	<b>58</b>

# AMBO FEMENINO

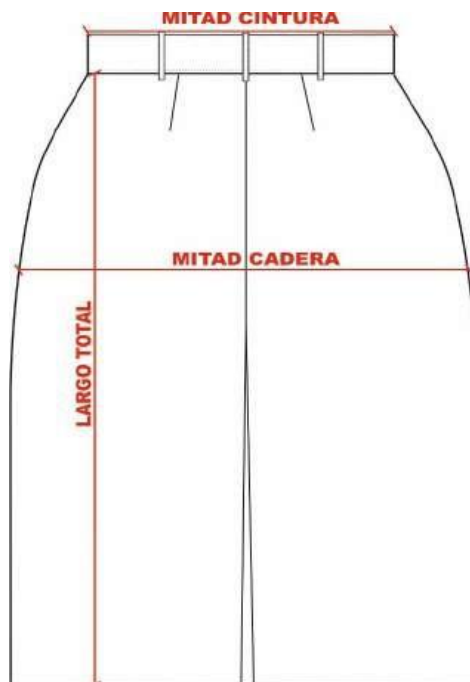
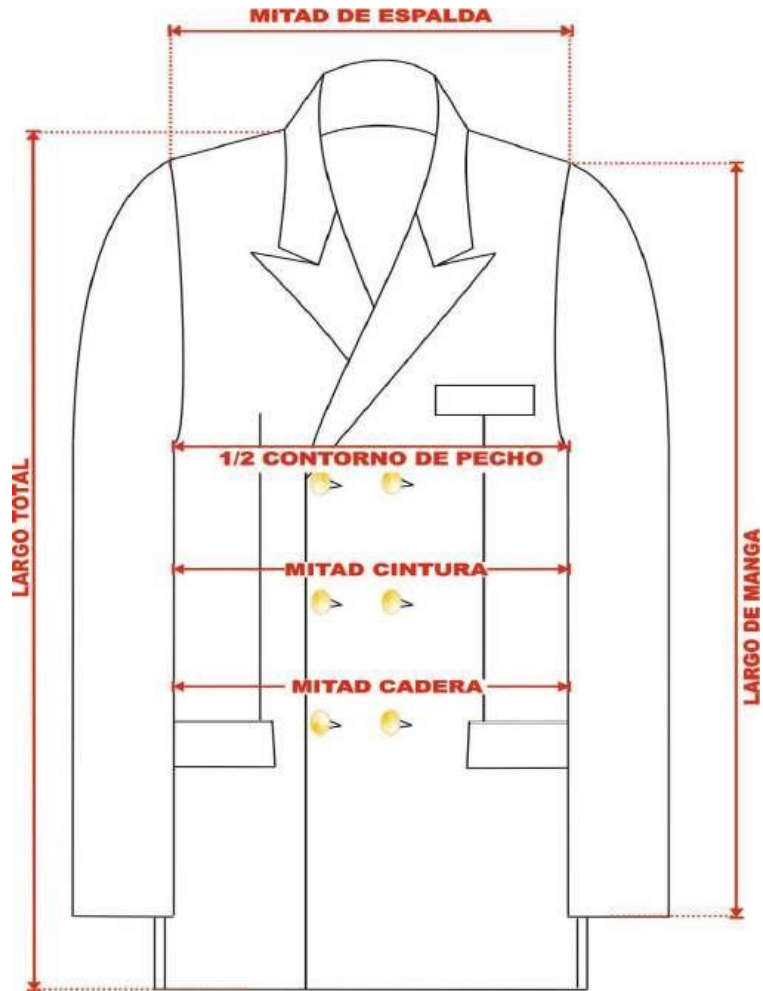

**SACO**

<b>TALLE</b>	<b>LARGO TOTAL</b>	<b>MITAD ESPALDA</b>	<b>LARGO DE MANGA</b>	<b>MITAD CINTURA</b>	<b>MITAD CADERA</b>
<b>36 C</b>	<b>64</b>	<b>15,5</b>	<b>60</b>	<b>30</b>	<b>42</b>
<b>36 M</b>	<b>67</b>	<b>15,5</b>	<b>63</b>	<b>30</b>	<b>42</b>
<b>36 L</b>	<b>72</b>	<b>15,5</b>	<b>65</b>	<b>30</b>	<b>42</b>
<b>38 C</b>	<b>64</b>	<b>16</b>	<b>60</b>	<b>32</b>	<b>44</b>
<b>38 M</b>	<b>67</b>	<b>16</b>	<b>63</b>	<b>32</b>	<b>44</b>
<b>38 L</b>	<b>72</b>	<b>16</b>	<b>65</b>	<b>32</b>	<b>44</b>
<b>40 C</b>	<b>64</b>	<b>16.5</b>	<b>60</b>	<b>34</b>	<b>46</b>
<b>40 M</b>	<b>67</b>	<b>16.5</b>	<b>63</b>	<b>34</b>	<b>46</b>
<b>40 L</b>	<b>72</b>	<b>16.5</b>	<b>65</b>	<b>34</b>	<b>46</b>
<b>42 C</b>	<b>64</b>	<b>17</b>	<b>60</b>	<b>36</b>	<b>48</b>
<b>42 M</b>	<b>67</b>	<b>17</b>	<b>63</b>	<b>36</b>	<b>48</b>
<b>42 L</b>	<b>72</b>	<b>17</b>	<b>65</b>	<b>36</b>	<b>48</b>
<b>44 C</b>	<b>64</b>	<b>18,5</b>	<b>60</b>	<b>38</b>	<b>50</b>
<b>44 M</b>	<b>67</b>	<b>18,5</b>	<b>63</b>	<b>38</b>	<b>50</b>
<b>44 L</b>	<b>72</b>	<b>18,5</b>	<b>65</b>	<b>38</b>	<b>50</b>
<b>46 C</b>	<b>64</b>	<b>19</b>	<b>60</b>	<b>40</b>	<b>52</b>
<b>46 M</b>	<b>67</b>	<b>19</b>	<b>63</b>	<b>40</b>	<b>52</b>
<b>46 L</b>	<b>72</b>	<b>19</b>	<b>65</b>	<b>40</b>	<b>52</b>
<b>48 C</b>	<b>64</b>	<b>19.5</b>	<b>60</b>	<b>42</b>	<b>54</b>
<b>48 M</b>	<b>67</b>	<b>19.5</b>	<b>63</b>	<b>42</b>	<b>54</b>
<b>48 L</b>	<b>72</b>	<b>19.5</b>	<b>65</b>	<b>42</b>	<b>54</b>
<b>50 C</b>	<b>64</b>	<b>20,5</b>	<b>60</b>	<b>44</b>	<b>56</b>

<b>50 M</b>	<b>67</b>	<b>20,5</b>	<b>63</b>	<b>44</b>	<b>56</b>
<b>50 L</b>	<b>72</b>	<b>20,5</b>	<b>65</b>	<b>44</b>	<b>56</b>
<b>52 C</b>	<b>64</b>	<b>21,5</b>	<b>60</b>	<b>46</b>	<b>58</b>
<b>52 M</b>	<b>67</b>	<b>21,5</b>	<b>63</b>	<b>46</b>	<b>58</b>
<b>52 L</b>	<b>72</b>	<b>21,5</b>	<b>65</b>	<b>46</b>	<b>58</b>
<b>54 C</b>	<b>64</b>	<b>22</b>	<b>60</b>	<b>48</b>	<b>60</b>
<b>54 M</b>	<b>67</b>	<b>22</b>	<b>63</b>	<b>48</b>	<b>60</b>
<b>54 L</b>	<b>72</b>	<b>22</b>	<b>65</b>	<b>48</b>	<b>60</b>

### **FALDA**

<b>TALLE</b>	<b>MITAD CINTURA</b>	<b>MITAD CADERA</b>	<b>LARGO TOTAL</b>
<b>40</b>	<b>32</b>	<b>46</b>	<b>60</b>
<b>42</b>	<b>34</b>	<b>48</b>	<b>60</b>
<b>44</b>	<b>36</b>	<b>50</b>	<b>60</b>
<b>46</b>	<b>38</b>	<b>52</b>	<b>62</b>
<b>48</b>	<b>40</b>	<b>54</b>	<b>62</b>
<b>50</b>	<b>42</b>	<b>56</b>	<b>62</b>
<b>52</b>	<b>44</b>	<b>58</b>	<b>64</b>
<b>54</b>	<b>46</b>	<b>60</b>	<b>64</b>
<b>56</b>	<b>48</b>	<b>62</b>	<b>64</b>
<b>58</b>	<b>50</b>	<b>64</b>	<b>66</b>
<b>60</b>	<b>52</b>	<b>66</b>	<b>68</b>

## AMBO SANIDAD

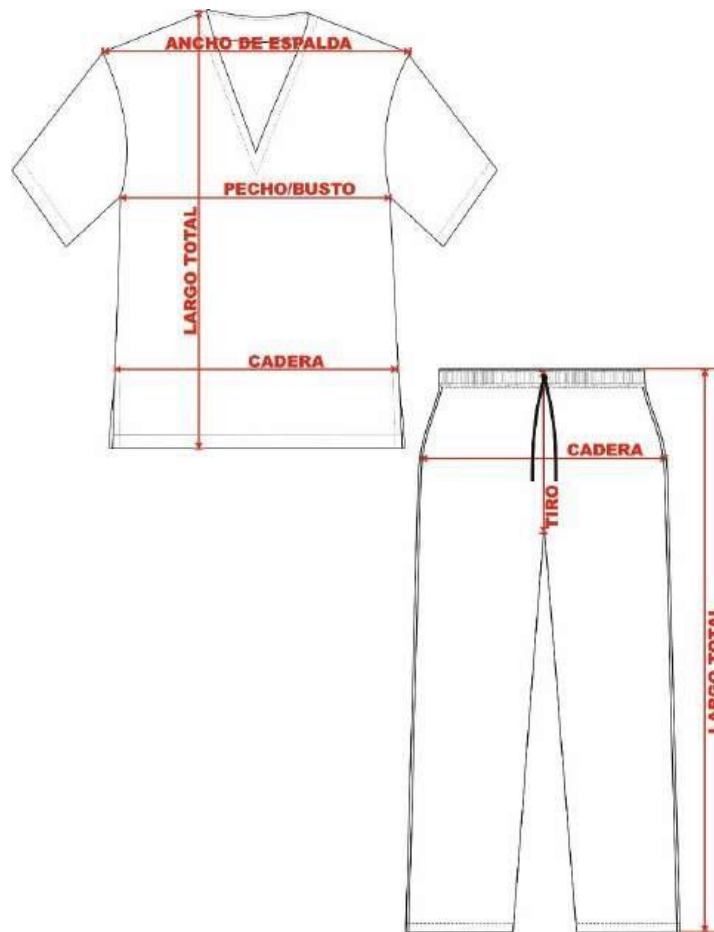

### CHAQUETA

TALLE	HOMBRO	BUSTO/PECHO	CADERA	LARGO
S	42	50	51	70
M	45	57	56	73
L	49	60	61	76
XL	52	65	66	79
2XL	54	70	71	82
3XL	57	75	76	85

### PANTALON

TALLE	TIRO	CADERA	LARGO
S	35	49	102
M	36	53	102
L	38	57	103
XL	39	61	103
2XL	39	65	105
3XL	40	69	105

# BLUSA MARINERA



**BLUSA MASCULINA**

<b>TALLE</b>		<b>LARGO TOTAL</b>	<b>ANCHO DE ESPALDA</b>	<b>ANCHO DE PECHO</b>	<b>LARGO DE MANGA</b>
	<b>C</b>	<b>59</b>	<b>35</b>	<b>44</b>	<b>59</b>
<b>38</b>	<b>M</b>	<b>63</b>	<b>35</b>	<b>44</b>	<b>62</b>
	<b>L</b>	<b>67</b>	<b>35</b>	<b>44</b>	<b>65</b>
	<b>C</b>	<b>59</b>	<b>36</b>	<b>46</b>	<b>60</b>
<b>40</b>	<b>M</b>	<b>63</b>	<b>36</b>	<b>46</b>	<b>63</b>
	<b>L</b>	<b>67</b>	<b>36</b>	<b>46</b>	<b>66</b>
	<b>C</b>	<b>59</b>	<b>37</b>	<b>48</b>	<b>60</b>
<b>42</b>	<b>M</b>	<b>63</b>	<b>37</b>	<b>48</b>	<b>63</b>
	<b>L</b>	<b>67</b>	<b>37</b>	<b>48</b>	<b>66</b>
	<b>C</b>	<b>59</b>	<b>38</b>	<b>50</b>	<b>60</b>
<b>44</b>	<b>M</b>	<b>63</b>	<b>38</b>	<b>50</b>	<b>63</b>
	<b>L</b>	<b>67</b>	<b>38</b>	<b>50</b>	<b>66</b>
	<b>C</b>	<b>59</b>	<b>39</b>	<b>52</b>	<b>60</b>
<b>46</b>	<b>M</b>	<b>63</b>	<b>39</b>	<b>52</b>	<b>63</b>
	<b>L</b>	<b>67</b>	<b>39</b>	<b>52</b>	<b>66</b>
	<b>C</b>	<b>60</b>	<b>41</b>	<b>54</b>	<b>61</b>
<b>48</b>	<b>M</b>	<b>64</b>	<b>41</b>	<b>54</b>	<b>64</b>
	<b>L</b>	<b>68</b>	<b>41</b>	<b>54</b>	<b>67</b>
	<b>C</b>	<b>60</b>	<b>42</b>	<b>56</b>	<b>61</b>
<b>50</b>	<b>M</b>	<b>64</b>	<b>42</b>	<b>56</b>	<b>64</b>
	<b>L</b>	<b>68</b>	<b>42</b>	<b>56</b>	<b>67</b>
	<b>C</b>	<b>60</b>	<b>43</b>	<b>58</b>	<b>61</b>
<b>52</b>	<b>M</b>	<b>64</b>	<b>43</b>	<b>58</b>	<b>64</b>
	<b>L</b>	<b>68</b>	<b>43</b>	<b>58</b>	<b>67</b>
	<b>C</b>	<b>60</b>	<b>44</b>	<b>60</b>	<b>61</b>
<b>54</b>	<b>M</b>	<b>64</b>	<b>44</b>	<b>60</b>	<b>64</b>
	<b>L</b>	<b>68</b>	<b>44</b>	<b>60</b>	<b>67</b>
	<b>C</b>	<b>60</b>	<b>45</b>	<b>62</b>	<b>61</b>
<b>56</b>	<b>M</b>	<b>64</b>	<b>45</b>	<b>62</b>	<b>64</b>
	<b>L</b>	<b>68</b>	<b>45</b>	<b>62</b>	<b>67</b>
	<b>C</b>	<b>60</b>	<b>46</b>	<b>64</b>	<b>61</b>
<b>58</b>	<b>M</b>	<b>64</b>	<b>46</b>	<b>64</b>	<b>64</b>
	<b>L</b>	<b>68</b>	<b>46</b>	<b>64</b>	<b>67</b>
	<b>C</b>	<b>60</b>	<b>47</b>	<b>66</b>	<b>61</b>
<b>60</b>	<b>M</b>	<b>64</b>	<b>47</b>	<b>66</b>	<b>64</b>
	<b>L</b>	<b>68</b>	<b>47</b>	<b>66</b>	<b>67</b>

**BLUSA FEMENINA**

<b>TALLE</b>		<b>LARGO TOTAL</b>	<b>ANCHO DE ESPALDA</b>	<b>ANCHO DE PECHO</b>	<b>LARGO DE MANGA</b>
	<b>C</b>	<b>62</b>	<b>34</b>	<b>42</b>	<b>58</b>
<b>38</b>	<b>M</b>	<b>62</b>	<b>34</b>	<b>42</b>	<b>58</b>
	<b>L</b>	<b>62</b>	<b>34</b>	<b>42</b>	<b>58</b>
	<b>C</b>	<b>63</b>	<b>34</b>	<b>44</b>	<b>58</b>
<b>40</b>	<b>M</b>	<b>63</b>	<b>34</b>	<b>44</b>	<b>58</b>
	<b>L</b>	<b>63</b>	<b>34</b>	<b>44</b>	<b>58</b>
	<b>C</b>	<b>63</b>	<b>35</b>	<b>46</b>	<b>58</b>
<b>42</b>	<b>M</b>	<b>63</b>	<b>35</b>	<b>46</b>	<b>58</b>
	<b>L</b>	<b>63</b>	<b>35</b>	<b>46</b>	<b>58</b>
	<b>C</b>	<b>63</b>	<b>36</b>	<b>48</b>	<b>58</b>
<b>44</b>	<b>M</b>	<b>63</b>	<b>36</b>	<b>48</b>	<b>58</b>
	<b>L</b>	<b>63</b>	<b>36</b>	<b>48</b>	<b>58</b>
	<b>C</b>	<b>63</b>	<b>37</b>	<b>50</b>	<b>58</b>
<b>46</b>	<b>M</b>	<b>63</b>	<b>37</b>	<b>50</b>	<b>58</b>
	<b>L</b>	<b>63</b>	<b>37</b>	<b>50</b>	<b>58</b>
	<b>C</b>	<b>64</b>	<b>39</b>	<b>52</b>	<b>59</b>
<b>48</b>	<b>M</b>	<b>64</b>	<b>39</b>	<b>52</b>	<b>59</b>
	<b>L</b>	<b>64</b>	<b>39</b>	<b>52</b>	<b>59</b>
	<b>C</b>	<b>64</b>	<b>40</b>	<b>54</b>	<b>59</b>
<b>50</b>	<b>M</b>	<b>64</b>	<b>40</b>	<b>54</b>	<b>59</b>
	<b>L</b>	<b>64</b>	<b>40</b>	<b>54</b>	<b>59</b>
	<b>C</b>	<b>64</b>	<b>41</b>	<b>56</b>	<b>59</b>
<b>52</b>	<b>M</b>	<b>64</b>	<b>41</b>	<b>56</b>	<b>59</b>
	<b>L</b>	<b>64</b>	<b>41</b>	<b>56</b>	<b>59</b>
	<b>C</b>	<b>64</b>	<b>42</b>	<b>58</b>	<b>59</b>
<b>54</b>	<b>M</b>	<b>64</b>	<b>42</b>	<b>58</b>	<b>59</b>
	<b>L</b>	<b>64</b>	<b>42</b>	<b>58</b>	<b>59</b>
	<b>C</b>	<b>64</b>	<b>43</b>	<b>60</b>	<b>59</b>
<b>56</b>	<b>M</b>	<b>64</b>	<b>43</b>	<b>60</b>	<b>59</b>
	<b>L</b>	<b>64</b>	<b>43</b>	<b>60</b>	<b>59</b>
	<b>C</b>	<b>64</b>	<b>44</b>	<b>62</b>	<b>59</b>
<b>58</b>	<b>M</b>	<b>64</b>	<b>44</b>	<b>62</b>	<b>59</b>
	<b>L</b>	<b>64</b>	<b>44</b>	<b>62</b>	<b>59</b>
	<b>C</b>	<b>65</b>	<b>45</b>	<b>64</b>	<b>59</b>
<b>60</b>	<b>M</b>	<b>65</b>	<b>45</b>	<b>64</b>	<b>59</b>
	<b>L</b>	<b>65</b>	<b>45</b>	<b>64</b>	<b>59</b>

# PANTALON Y FALDA MARINERA

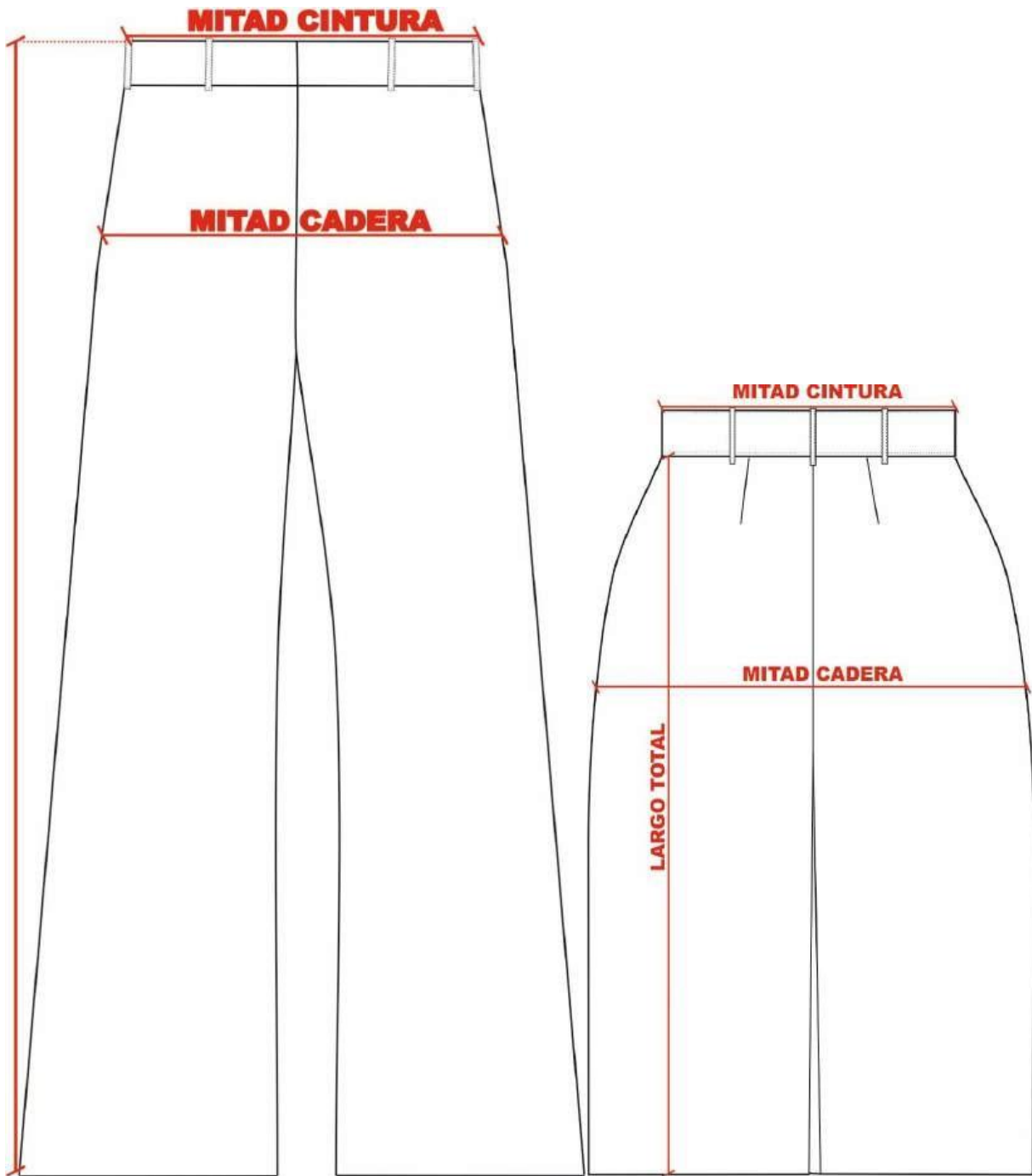

**PANTALON MARINERO UNISEX**

<b>TALLE</b>	<b>LARGO TOTAL</b>	<b>MITAD CINTURA</b>	<b>MITAD CADERA</b>
<b>36 A</b>	<b>102</b>	<b>36</b>	<b>44</b>
<b>36 N</b>	<b>98</b>	<b>36</b>	<b>44</b>
<b>36 B</b>	<b>92</b>	<b>36</b>	<b>44</b>
<b>38 A</b>	<b>102</b>	<b>38</b>	<b>46</b>
<b>38 N</b>	<b>98</b>	<b>38</b>	<b>46</b>
<b>38 B</b>	<b>92</b>	<b>38</b>	<b>46</b>
<b>40 A</b>	<b>104</b>	<b>40</b>	<b>48</b>
<b>40 N</b>	<b>99</b>	<b>40</b>	<b>48</b>
<b>40 B</b>	<b>94</b>	<b>40</b>	<b>48</b>
<b>42 A</b>	<b>104</b>	<b>42</b>	<b>50</b>
<b>42 N</b>	<b>99</b>	<b>42</b>	<b>50</b>
<b>42 B</b>	<b>94</b>	<b>42</b>	<b>50</b>
<b>44 A</b>	<b>105</b>	<b>44</b>	<b>52</b>
<b>44 N</b>	<b>100</b>	<b>44</b>	<b>52</b>
<b>44 B</b>	<b>96</b>	<b>44</b>	<b>52</b>
<b>46 A</b>	<b>105</b>	<b>46</b>	<b>54</b>
<b>46 N</b>	<b>100</b>	<b>46</b>	<b>54</b>
<b>46 B</b>	<b>96</b>	<b>46</b>	<b>54</b>
<b>48 A</b>	<b>105</b>	<b>48</b>	<b>56</b>
<b>48 N</b>	<b>100</b>	<b>48</b>	<b>56</b>
<b>48 B</b>	<b>96</b>	<b>48</b>	<b>56</b>
<b>50 A</b>	<b>107</b>	<b>50</b>	<b>58</b>
<b>50 N</b>	<b>102</b>	<b>50</b>	<b>58</b>

<b>50 B</b>	<b>98</b>	<b>50</b>	<b>58</b>
<b>52 A</b>	<b>107</b>	<b>52</b>	<b>60</b>
<b>52 N</b>	<b>102</b>	<b>52</b>	<b>60</b>
<b>52 B</b>	<b>98</b>	<b>52</b>	<b>60</b>
<b>54 A</b>	<b>108</b>	<b>54</b>	<b>61</b>
<b>54 N</b>	<b>103</b>	<b>54</b>	<b>61</b>
<b>54 B</b>	<b>98</b>	<b>54</b>	<b>61</b>
<b>56 A</b>	<b>108</b>	<b>56</b>	<b>62</b>
<b>56 N</b>	<b>103</b>	<b>56</b>	<b>62</b>
<b>56 B</b>	<b>98</b>	<b>56</b>	<b>62</b>
<b>58 A</b>	<b>109</b>	<b>58</b>	<b>64</b>
<b>58 N</b>	<b>104</b>	<b>58</b>	<b>64</b>
<b>58 B</b>	<b>99</b>	<b>58</b>	<b>64</b>
<b>60 A</b>	<b>109</b>	<b>60</b>	<b>66</b>
<b>60 N</b>	<b>104</b>	<b>60</b>	<b>66</b>
<b>60 B</b>	<b>99</b>	<b>60</b>	<b>66</b>

### **FALDA MARINERA**

<b>TALLE</b>	<b>MITAD CINTURA</b>	<b>MITAD CADERA</b>	<b>LARGO TOTAL</b>
<b>40</b>	<b>32</b>	<b>46</b>	<b>60</b>
<b>42</b>	<b>34</b>	<b>48</b>	<b>60</b>
<b>44</b>	<b>36</b>	<b>50</b>	<b>60</b>
<b>46</b>	<b>38</b>	<b>52</b>	<b>62</b>
<b>48</b>	<b>40</b>	<b>54</b>	<b>62</b>
<b>50</b>	<b>42</b>	<b>56</b>	<b>62</b>
<b>52</b>	<b>44</b>	<b>58</b>	<b>64</b>

<b>54</b>	<b>46</b>	<b>60</b>	<b>64</b>
<b>56</b>	<b>48</b>	<b>62</b>	<b>64</b>
<b>58</b>	<b>50</b>	<b>64</b>	<b>66</b>
<b>60</b>	<b>52</b>	<b>66</b>	<b>68</b>

## CUELLO MARINERO

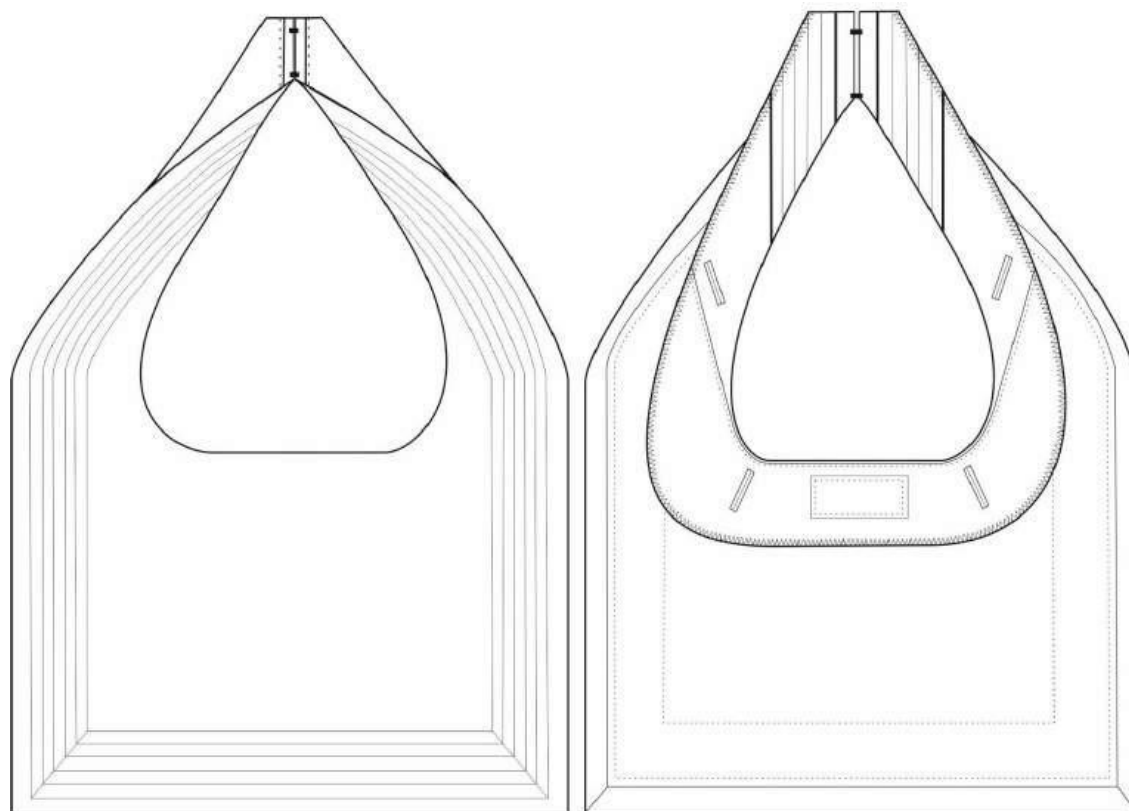

## MEDIDAS SEGÚN ESCOTE DE LA BLUSA MARINERA

TALLE	LARGO TOTAL	ANCHO DEL ESCOTE		LARGO PARTE CENTRAL
		P. SUPERIOR	P. INFERIOR	
<b>40/42</b>	<b>46,5</b>	<b>29,5</b>	<b>27</b>	<b>17</b>
<b>44/46</b>	<b>48,5</b>	<b>31,5</b>	<b>29</b>	<b>19</b>
<b>48/50</b>	<b>50,5</b>	<b>32,5</b>	<b>31</b>	<b>20</b>
<b>52/54</b>	<b>53,5</b>	<b>35,5</b>	<b>35</b>	<b>21</b>

SECTOR ESPECIFICACIONES TECNICAS

# POLAR CON CIERRE AZUL Y ESCOTE EN V VERDE OLIVA



# CAMISAS



**MANGA LARGA MASCULINA**

<b>TALLE</b>	<b>CONTORNO DE CUELLO</b>	<b>ANCHO DE PECHO</b>	<b>ANCHO DE ESPALDA</b>	<b>LARGO DE MANGA</b>
	<b>C</b>			<b>74.5</b>
<b>36</b>	<b>M</b>	<b>38</b>	<b>55</b>	<b>44.5</b>
	<b>L</b>			<b>76.5</b>
	<b>C</b>			<b>78.5</b>
<b>38</b>	<b>M</b>	<b>39</b>	<b>57</b>	<b>46</b>
	<b>L</b>			<b>76.5</b>
	<b>C</b>			<b>78.5</b>
<b>40</b>	<b>M</b>	<b>41</b>	<b>59</b>	<b>50</b>
	<b>L</b>			<b>76.5</b>
	<b>C</b>			<b>78.5</b>
<b>42</b>	<b>M</b>	<b>42</b>	<b>61.5</b>	<b>51</b>
	<b>L</b>			<b>76</b>
	<b>C</b>			<b>78</b>
<b>44</b>	<b>M</b>	<b>43</b>	<b>65</b>	<b>53</b>
	<b>L</b>			<b>78</b>
	<b>C</b>			<b>79</b>
<b>46</b>	<b>M</b>	<b>44</b>	<b>67</b>	<b>55</b>
	<b>L</b>			<b>80</b>
	<b>C</b>			<b>81</b>
<b>48</b>	<b>M</b>	<b>45</b>	<b>69</b>	<b>57</b>
	<b>L</b>			<b>79</b>
	<b>C</b>			<b>81</b>
<b>50</b>	<b>M</b>	<b>46</b>	<b>71</b>	<b>59</b>
	<b>L</b>			<b>82</b>
	<b>C</b>			<b>83</b>

	L				<b>84</b>
	C				<b>81</b>
<b>52</b>	M	<b>47</b>	<b>73</b>	<b>61</b>	<b>83</b>
	L				<b>85</b>
	C				<b>82</b>
<b>54</b>	M	<b>48</b>	<b>75</b>	<b>63</b>	<b>84</b>
	L				<b>86</b>

### **MANGA LARGA FEMENINA**

<b>TALLE</b>	<b>CONTORNO DE CUELLO</b>	<b>ANCHO DE PECHO</b>	<b>ANCHO DE ESPALDA</b>	<b>LARGO DE MANGA</b>	<b>LARGO TOTAL</b>
	C			<b>55</b>	
<b>36</b>	M	<b>31</b>	<b>40</b>	<b>58</b>	<b>67</b>
	L			<b>61</b>	
	C			<b>58</b>	
<b>38</b>	M	<b>32</b>	<b>42</b>	<b>61</b>	<b>68</b>
	L			<b>64</b>	
	C			<b>58</b>	
<b>40</b>	M	<b>33</b>	<b>44</b>	<b>61</b>	<b>68</b>
	L			<b>64</b>	
	C			<b>59</b>	
<b>42</b>	M	<b>34</b>	<b>46</b>	<b>62</b>	<b>68</b>
	L			<b>65</b>	
	C			<b>59</b>	
<b>44</b>	M	<b>35</b>	<b>48</b>	<b>62</b>	<b>69</b>
	L			<b>65</b>	

	C				<b>60</b>	
<b>46</b>	M	<b>36</b>	<b>50</b>	<b>41</b>	<b>63</b>	<b>69</b>
	L				<b>66</b>	
	C				<b>60</b>	
<b>48</b>	M	<b>37</b>	<b>52</b>	<b>42</b>	<b>63</b>	<b>70</b>
	L				<b>66</b>	
	C				<b>61</b>	
<b>50</b>	M	<b>38</b>	<b>54</b>	<b>43</b>	<b>64</b>	<b>70</b>
	L				<b>67</b>	
	C				<b>61</b>	
<b>52</b>	M	<b>39</b>	<b>57</b>	<b>44</b>	<b>64</b>	<b>71</b>
	L				<b>67</b>	
	C				<b>61</b>	
<b>54</b>	M	<b>40</b>	<b>60</b>	<b>46</b>	<b>64</b>	<b>71</b>
	L				<b>67</b>	

## MANGA CORTA



**MANGA CORTA MASCULINA**

<b>TALLE</b>	<b>LARGO DE CUELLO</b>	<b>MITAD ANCHO DE PECHO</b>	<b>ANCHO DE ESPALDA</b>	<b>LARGO DE ESPALDA</b>	<b>LARGO DE MANGA</b>
<b>36/37</b>	<b>36,5</b>	<b>55</b>	<b>44</b>	<b>76</b>	<b>24</b>
<b>38/39</b>	<b>38,5</b>	<b>57</b>	<b>46</b>	<b>76</b>	<b>24</b>
<b>40/41</b>	<b>40,5</b>	<b>59</b>	<b>48</b>	<b>76</b>	<b>24</b>
<b>42/43</b>	<b>42,5</b>	<b>61</b>	<b>50</b>	<b>81</b>	<b>24</b>
<b>44/45</b>	<b>44,5</b>	<b>64</b>	<b>52</b>	<b>81</b>	<b>24</b>

**MANGA CORTA FEMENINA**

<b>TALLE</b>	<b>LARGO DE CUELLO</b>	<b>MEDIO PECHO</b>	<b>ANCHO DE ESPALDA</b>	<b>LARGO DE ESPALDA</b>	<b>LARGO DE MANGA</b>
<b>38</b>	<b>32</b>	<b>42</b>	<b>37</b>	<b>68</b>	<b>23</b>
<b>40</b>	<b>33</b>	<b>44</b>	<b>38</b>	<b>68</b>	<b>23</b>
<b>42</b>	<b>34</b>	<b>46</b>	<b>39</b>	<b>68</b>	<b>23</b>
<b>44</b>	<b>35</b>	<b>48</b>	<b>40</b>	<b>69</b>	<b>23</b>
<b>46</b>	<b>36</b>	<b>50</b>	<b>41</b>	<b>69</b>	<b>24</b>
<b>48</b>	<b>37</b>	<b>52</b>	<b>42</b>	<b>70</b>	<b>24</b>
<b>50</b>	<b>38</b>	<b>54</b>	<b>43</b>	<b>70</b>	<b>26</b>
<b>52</b>	<b>39</b>	<b>57</b>	<b>44</b>	<b>71</b>	<b>27</b>
<b>54</b>	<b>40</b>	<b>60</b>	<b>46</b>	<b>71</b>	<b>27</b>
<b>56</b>	<b>40</b>	<b>63</b>	<b>48</b>	<b>71</b>	<b>27</b>

## CAMISETA CON PECHERA BLANCA Y VERDE OLIVA



TALLE	ANCHO PECHO		LARGO TOTAL		LARGO DE MANGA
	MIN	MAX	MIN	MAX	
1	43	46	77	80	62
2	46	49	80	83	64
3	49	52	83	86	67

## CAMISETA BLANCA, VERDE OLIVA, PARA DEPORTE Y POLIVALENTE



TALLE	LARGO TOTAL		ANCHO DE PECHO		MEDIDA DE HOMBRO A HOMBRO		LARGO DE MANGA	
	Min	Max	Min	Max	Min	Max	Min	Max
S	72	74	38	40	35	37	22	24
	72	74	39	41	36	38	22	24
M	74	75	45	47	42	43	22	24
	76	77	49	51	45	47	22	24
L	78	81	53	55	49	51	22	24
	80	82	55	57	51	53	22	24
XL	82	85	57	59	53	55	22	24
	84	85	58	60	55	56	22	24

## POLIVALENTE Y POLIVALENTE INSTITUTO (UCAN)

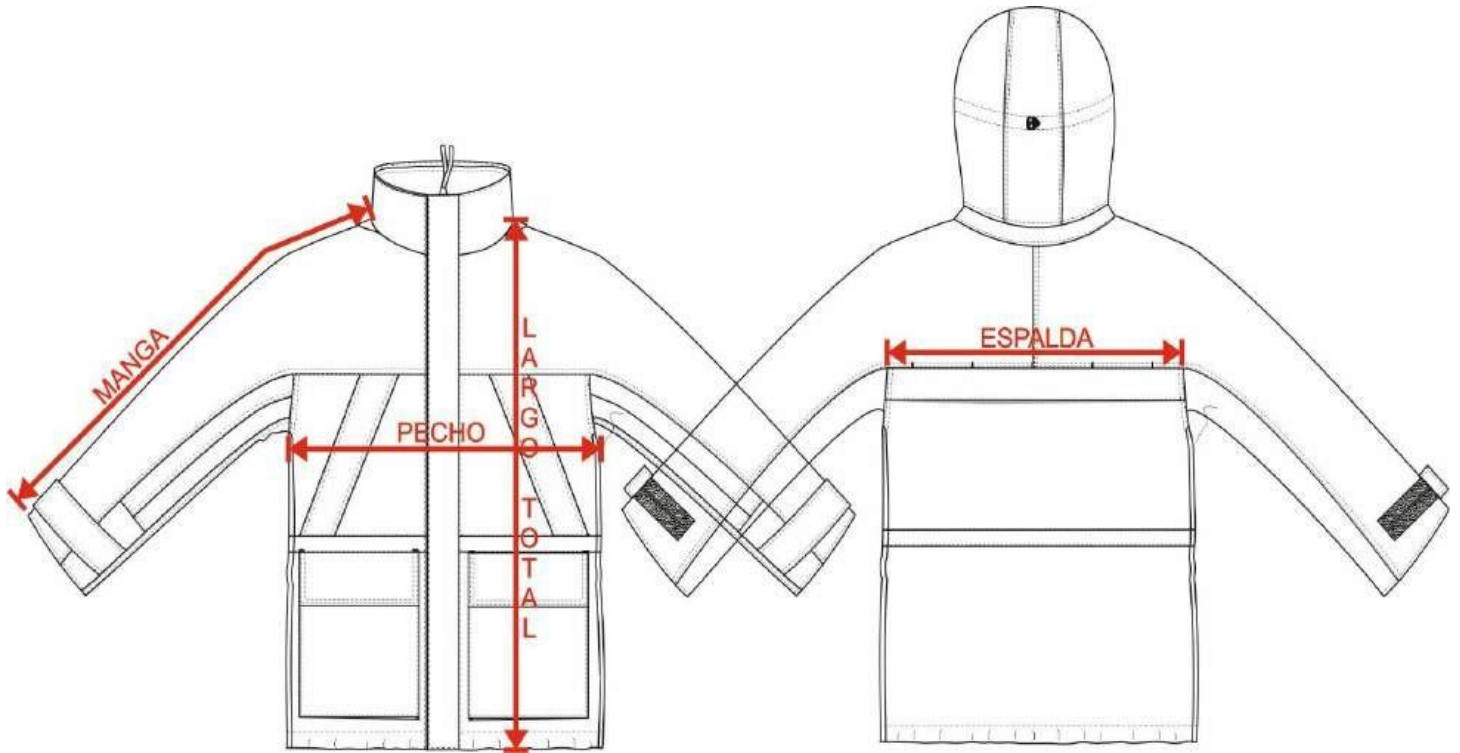

TALLE	LARGO TOTAL	PECHO	ESPALDA	MANGA
S	76	62	54	80
M	78	65	57	82
L	80	68	60	86
XL	82	71	63	88
XXL	84	74	66	91

# CAPOTE

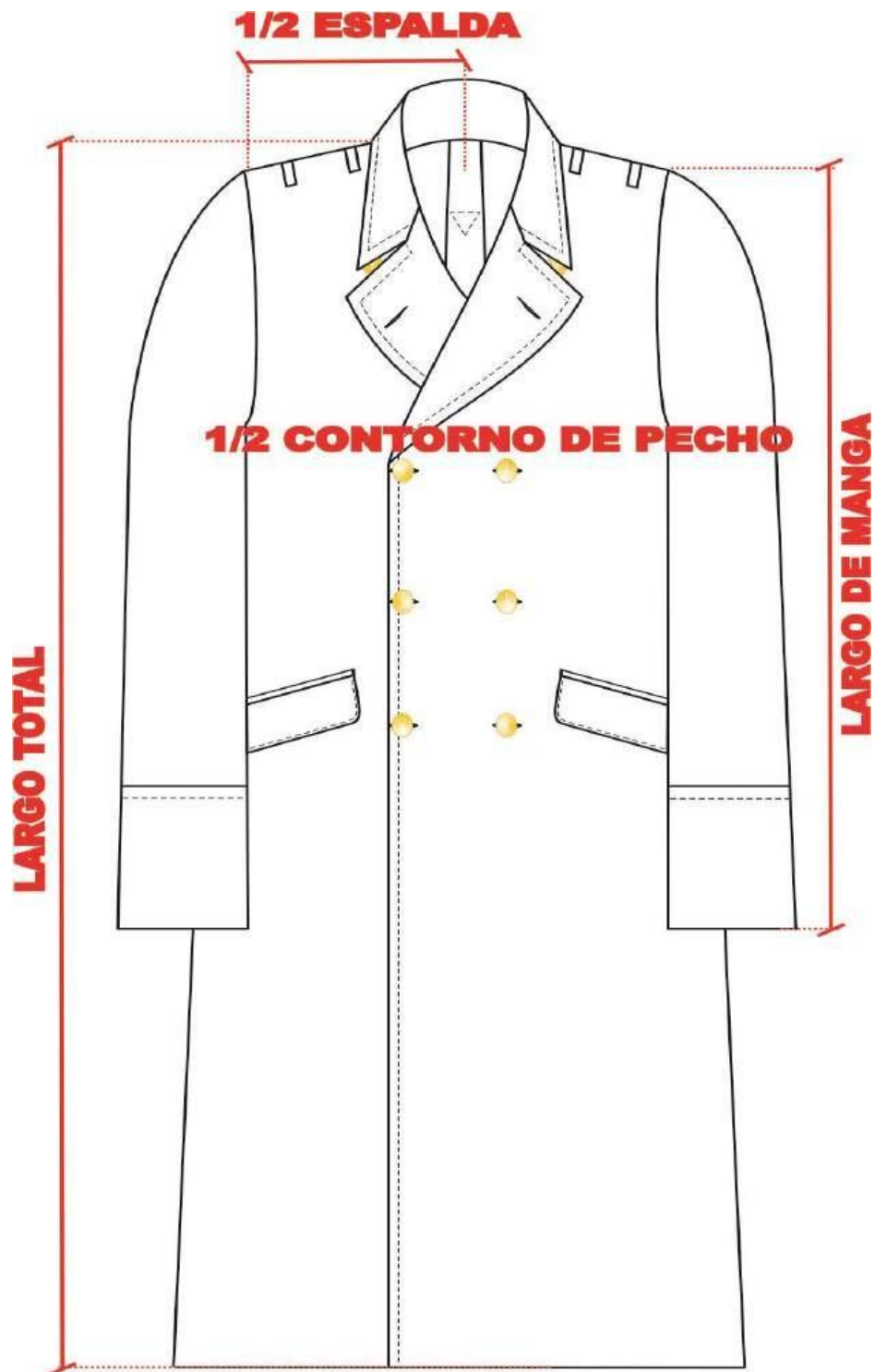

**CAPOTE MASCULINO**

<b>TALLE</b>	<b>LARGO TOTAL</b>	<b>MEDIA ESPALDA</b>	<b>LARGO MANGA</b>	<b>MITAD CONTORNO PECHO</b>
<b>C</b>	<b>105</b>	<b>21,0</b>	<b>60</b>	<b>44</b>
<b>40 M</b>	<b>115</b>	<b>21,0</b>	<b>62</b>	<b>44</b>
<b>L</b>	<b>120</b>	<b>21,0</b>	<b>64</b>	<b>44</b>
<b>C</b>	<b>105</b>	<b>21,5</b>	<b>60</b>	<b>46</b>
<b>42 M</b>	<b>115</b>	<b>21,5</b>	<b>62</b>	<b>46</b>
<b>L</b>	<b>120</b>	<b>21,5</b>	<b>64</b>	<b>46</b>
<b>C</b>	<b>105</b>	<b>22,0</b>	<b>60</b>	<b>48</b>
<b>44 M</b>	<b>115</b>	<b>22,0</b>	<b>62</b>	<b>48</b>
<b>L</b>	<b>120</b>	<b>22,0</b>	<b>64</b>	<b>48</b>
<b>C</b>	<b>105</b>	<b>22,5</b>	<b>60</b>	<b>50</b>
<b>46 M</b>	<b>115</b>	<b>22,5</b>	<b>62</b>	<b>50</b>
<b>L</b>	<b>120</b>	<b>22,5</b>	<b>64</b>	<b>50</b>
<b>C</b>	<b>105</b>	<b>23,0</b>	<b>60</b>	<b>52</b>
<b>48 M</b>	<b>115</b>	<b>23,0</b>	<b>62</b>	<b>52</b>
<b>L</b>	<b>120</b>	<b>23,0</b>	<b>64</b>	<b>52</b>
<b>C</b>	<b>105</b>	<b>23,5</b>	<b>60</b>	<b>54</b>
<b>50 M</b>	<b>115</b>	<b>23,5</b>	<b>62</b>	<b>54</b>
<b>L</b>	<b>120</b>	<b>23,5</b>	<b>64</b>	<b>54</b>
<b>C</b>	<b>105</b>	<b>24,0</b>	<b>60</b>	<b>56</b>
<b>52 M</b>	<b>115</b>	<b>24,0</b>	<b>62</b>	<b>56</b>
<b>L</b>	<b>120</b>	<b>24,0</b>	<b>64</b>	<b>56</b>
<b>C</b>	<b>105</b>	<b>24,5</b>	<b>60</b>	<b>58</b>

<b>54 M</b>	<b>115</b>	<b>24,5</b>	<b>62</b>	<b>58</b>
<b>L</b>	<b>120</b>	<b>24,5</b>	<b>64</b>	<b>58</b>
<b>C</b>	<b>105</b>	<b>25,0</b>	<b>60</b>	<b>60</b>
<b>56 M</b>	<b>115</b>	<b>25,0</b>	<b>62</b>	<b>60</b>
<b>L</b>	<b>120</b>	<b>25,0</b>	<b>64</b>	<b>60</b>
<b>C</b>	<b>105</b>	<b>25,5</b>	<b>60</b>	<b>62</b>
<b>58 M</b>	<b>115</b>	<b>25,5</b>	<b>62</b>	<b>62</b>
<b>L</b>	<b>120</b>	<b>25,5</b>	<b>64</b>	<b>62</b>
<b>C</b>	<b>105</b>	<b>26,0</b>	<b>60</b>	<b>64</b>
<b>60 M</b>	<b>115</b>	<b>26,0</b>	<b>62</b>	<b>64</b>
<b>L</b>	<b>120</b>	<b>26,0</b>	<b>64</b>	<b>64</b>

### **CAPOTE FEMENINO**

<b>TALLE</b>	<b>LARGO TOTAL</b>	<b>MEDIDA ESPALDA</b>	<b>LARGO MANGAS</b>	<b>1/2 CONTORNO DE PECHO</b>
<b>42 M</b>	<b>95</b>	<b>19,5</b>	<b>53</b>	<b>48</b>
<b>L</b>	<b>100</b>	<b>19,5</b>	<b>55</b>	<b>48</b>
<b>C</b>	<b>105</b>	<b>19,5</b>	<b>58</b>	<b>48</b>
<b>44 M</b>	<b>95</b>	<b>20</b>	<b>53</b>	<b>50</b>
<b>L</b>	<b>100</b>	<b>20</b>	<b>55</b>	<b>50</b>
<b>C</b>	<b>105</b>	<b>20</b>	<b>58</b>	<b>50</b>
<b>46 M</b>	<b>95</b>	<b>20,5</b>	<b>53</b>	<b>52</b>
<b>L</b>	<b>100</b>	<b>20,5</b>	<b>55</b>	<b>52</b>
<b>C</b>	<b>105</b>	<b>20,5</b>	<b>58</b>	<b>52</b>
<b>48 M</b>	<b>95</b>	<b>21</b>	<b>53</b>	<b>54</b>
<b>L</b>	<b>100</b>	<b>21</b>	<b>55</b>	<b>54</b>
<b>C</b>	<b>105</b>	<b>21</b>	<b>58</b>	<b>54</b>

<b>50 M</b>	<b>95</b>	<b>21,5</b>	<b>53</b>	<b>56</b>
<b>L</b>	<b>100</b>	<b>21,5</b>	<b>55</b>	<b>56</b>
<b>C</b>	<b>105</b>	<b>21,5</b>	<b>58</b>	<b>56</b>
<b>52 M</b>	<b>95</b>	<b>22,5</b>	<b>53</b>	<b>58</b>
<b>L</b>	<b>100</b>	<b>22,5</b>	<b>55</b>	<b>58</b>
<b>C</b>	<b>105</b>	<b>22,5</b>	<b>58</b>	<b>58</b>
<b>54 M</b>	<b>95</b>	<b>23</b>	<b>53</b>	<b>60</b>
<b>L</b>	<b>100</b>	<b>23</b>	<b>55</b>	<b>60</b>
<b>C</b>	<b>105</b>	<b>23</b>	<b>58</b>	<b>60</b>
<b>56 M</b>	<b>95</b>	<b>24</b>	<b>53</b>	<b>62</b>
<b>L</b>	<b>100</b>	<b>24</b>	<b>55</b>	<b>62</b>
<b>C</b>	<b>105</b>	<b>24</b>	<b>58</b>	<b>62</b>
<b>58 M</b>	<b>95</b>	<b>24,5</b>	<b>53</b>	<b>64</b>
<b>L</b>	<b>100</b>	<b>24,5</b>	<b>55</b>	<b>64</b>
<b>C</b>	<b>105</b>	<b>24,5</b>	<b>58</b>	<b>64</b>

# CHAQUETILLA IM



**CHAQUETILLA MASCULINA**

	<b>TALLE</b>	<b>LARGO TOTAL</b>	<b>½ ANCHO DE ESPALDA</b>	<b>LARGO DE MANGA</b>
	<b>C</b>	<b>69</b>		<b>56</b>
<b>40</b>	<b>M</b>	<b>74</b>	<b>18,5</b>	<b>59</b>
	<b>L</b>	<b>79</b>		<b>62</b>
	<b>C</b>	<b>71</b>		<b>57</b>
<b>42</b>	<b>M</b>	<b>76</b>	<b>19</b>	<b>60</b>
	<b>L</b>	<b>81</b>		<b>63</b>
	<b>C</b>	<b>71</b>		<b>57</b>
<b>44</b>	<b>M</b>	<b>76</b>	<b>19,5</b>	<b>60</b>
	<b>L</b>	<b>81</b>		<b>63</b>
	<b>C</b>	<b>71</b>		<b>57</b>
<b>46</b>	<b>M</b>	<b>76</b>	<b>20</b>	<b>60</b>
	<b>L</b>	<b>81</b>		<b>63</b>
	<b>C</b>	<b>72</b>		<b>57</b>
<b>48</b>	<b>M</b>	<b>77</b>	<b>20,5</b>	<b>60</b>
	<b>L</b>	<b>82</b>		<b>63</b>
	<b>C</b>	<b>72</b>		<b>57</b>
<b>50</b>	<b>M</b>	<b>77</b>	<b>21</b>	<b>60</b>
	<b>L</b>	<b>82</b>		<b>63</b>
	<b>C</b>	<b>73</b>		<b>57</b>
<b>52</b>	<b>M</b>	<b>78</b>	<b>22</b>	<b>60</b>
	<b>L</b>	<b>83</b>		<b>63</b>
	<b>C</b>	<b>73</b>		<b>57</b>

<b>54</b>	<b>M</b>	<b>78</b>	<b>23</b>	<b>60</b>
	<b>L</b>	<b>83</b>		<b>63</b>
	<b>C</b>	<b>73</b>		<b>57</b>
<b>56</b>	<b>M</b>	<b>78</b>	<b>24</b>	<b>60</b>
	<b>L</b>	<b>83</b>		<b>63</b>
	<b>C</b>	<b>74</b>		<b>57</b>
<b>58</b>	<b>M</b>	<b>79</b>	<b>25</b>	<b>60</b>
	<b>L</b>	<b>84</b>		<b>63</b>
	<b>C</b>	<b>74</b>		<b>57</b>
<b>60</b>	<b>M</b>	<b>79</b>	<b>26</b>	<b>60</b>
	<b>L</b>	<b>84</b>		<b>63</b>
	<b>C</b>	<b>75</b>		<b>57</b>
<b>62</b>	<b>M</b>	<b>80</b>	<b>26</b>	<b>60</b>
	<b>L</b>	<b>85</b>		<b>63</b>
	<b>C</b>	<b>75</b>		<b>57</b>
<b>64</b>	<b>M</b>	<b>80</b>	<b>26</b>	<b>60</b>
	<b>L</b>	<b>85</b>		<b>63</b>

**CHAQUETILLA FEMENINA**

<b>TALLE</b>		<b>LARGO TOTAL</b>	<b>½ ANCHO DE ESPALDA</b>	<b>LARGO DE MANGA</b>
	<b>C</b>	<b>62</b>		<b>51</b>
<b>36</b>	<b>M</b>	<b>65</b>	<b>16,5</b>	<b>53</b>
	<b>L</b>	<b>69</b>		<b>55</b>
	<b>C</b>	<b>63</b>		<b>52</b>
<b>38</b>	<b>M</b>	<b>66</b>	<b>17</b>	<b>54</b>
	<b>L</b>	<b>70</b>		<b>56</b>
	<b>C</b>	<b>63</b>		<b>52</b>
<b>40</b>	<b>M</b>	<b>66</b>	<b>17,5</b>	<b>54</b>
	<b>L</b>	<b>70</b>		<b>56</b>
	<b>C</b>	<b>63</b>		<b>52</b>
<b>42</b>	<b>M</b>	<b>66</b>	<b>18</b>	<b>54</b>
	<b>L</b>	<b>70</b>		<b>56</b>
	<b>C</b>	<b>65</b>		<b>52</b>
<b>44</b>	<b>M</b>	<b>68</b>	<b>19</b>	<b>54</b>
	<b>L</b>	<b>72</b>		<b>56</b>
	<b>C</b>	<b>65</b>		<b>52</b>
<b>46</b>	<b>M</b>	<b>68</b>	<b>19,5</b>	<b>54</b>
	<b>L</b>	<b>72</b>		<b>56</b>
	<b>C</b>	<b>65</b>		<b>52</b>
<b>48</b>	<b>M</b>	<b>68</b>	<b>20,5</b>	<b>54</b>
	<b>L</b>	<b>72</b>		<b>56</b>
	<b>C</b>	<b>65</b>		<b>52</b>
<b>50</b>	<b>M</b>	<b>68</b>	<b>21</b>	<b>54</b>

	<b>L</b>	<b>72</b>		<b>56</b>
	<b>C</b>	<b>65</b>		<b>52</b>
<b>52</b>	<b>M</b>	<b>68</b>	<b>22</b>	<b>54</b>
	<b>L</b>	<b>72</b>		<b>56</b>
	<b>C</b>	<b>65</b>		<b>52</b>
<b>54</b>	<b>M</b>	<b>68</b>	<b>22,5</b>	<b>54</b>
	<b>L</b>	<b>72</b>		<b>56</b>
	<b>C</b>	<b>66</b>		<b>53</b>
<b>56</b>	<b>M</b>	<b>69</b>	<b>23</b>	<b>55</b>
	<b>L</b>	<b>73</b>		<b>57</b>
	<b>C</b>	<b>67</b>		<b>53</b>
<b>58</b>	<b>M</b>	<b>70</b>	<b>23,5</b>	<b>55</b>
	<b>L</b>	<b>74</b>		<b>57</b>
	<b>C</b>	<b>67</b>		<b>54</b>
<b>60</b>	<b>M</b>	<b>70</b>	<b>24</b>	<b>56</b>
	<b>L</b>	<b>74</b>		<b>58</b>

## CAMPERA CAMUFLADO TELA RESPIRABLE (MULTICAM)

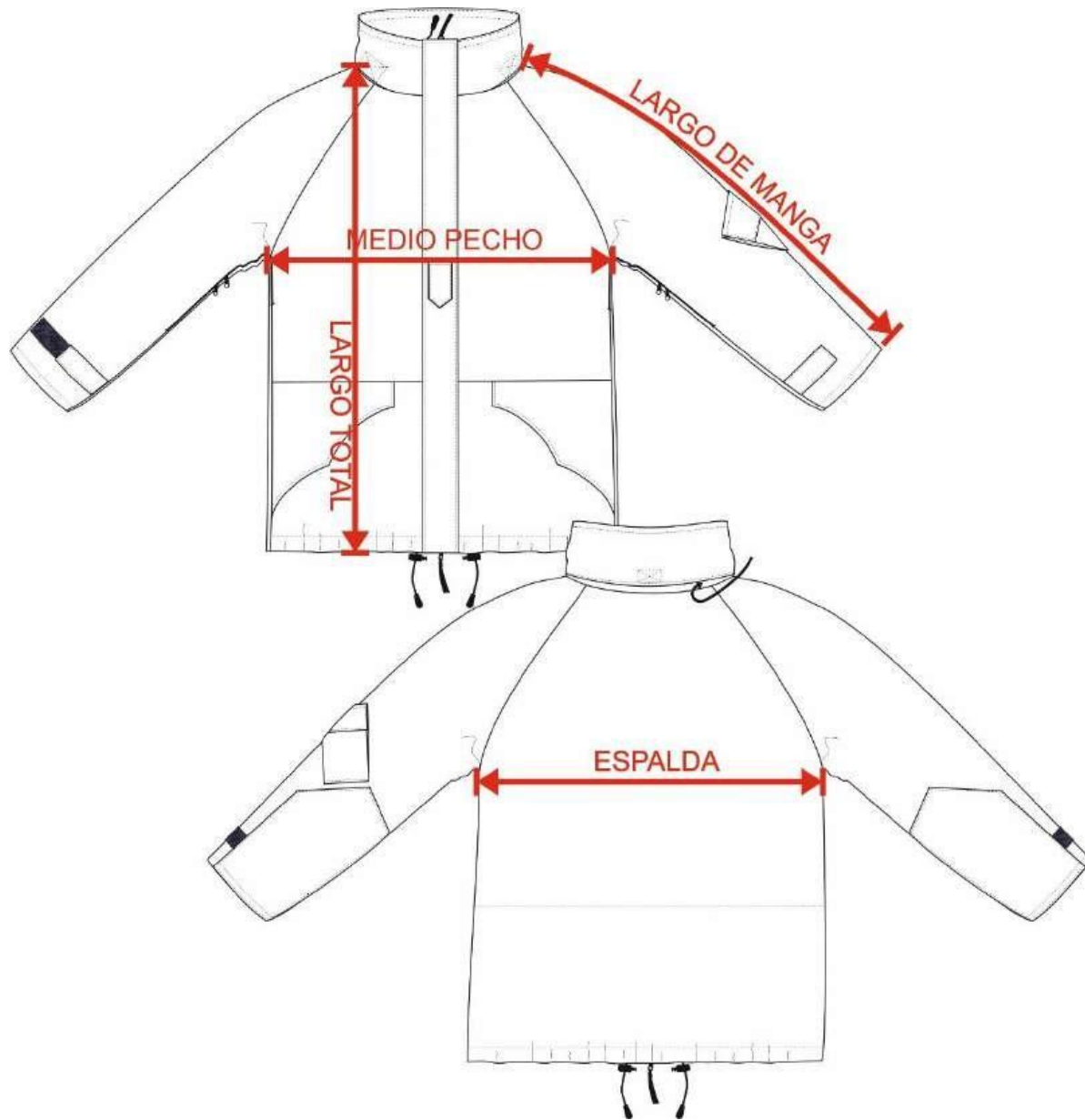

TALLE	LARGO TOTAL	LARGO DE MANGA	ESPALDA	MEDIO PECHO	BAJO MANGA
S	73	74	46	64	70
M	73	76	48	66	71
L	77	78	50	68	71
X	77	80	52	70	72
XX	82	82	54	72	72

## PANTALON CAMUFLADO TELA RESPIRABLE (MULTICAM)

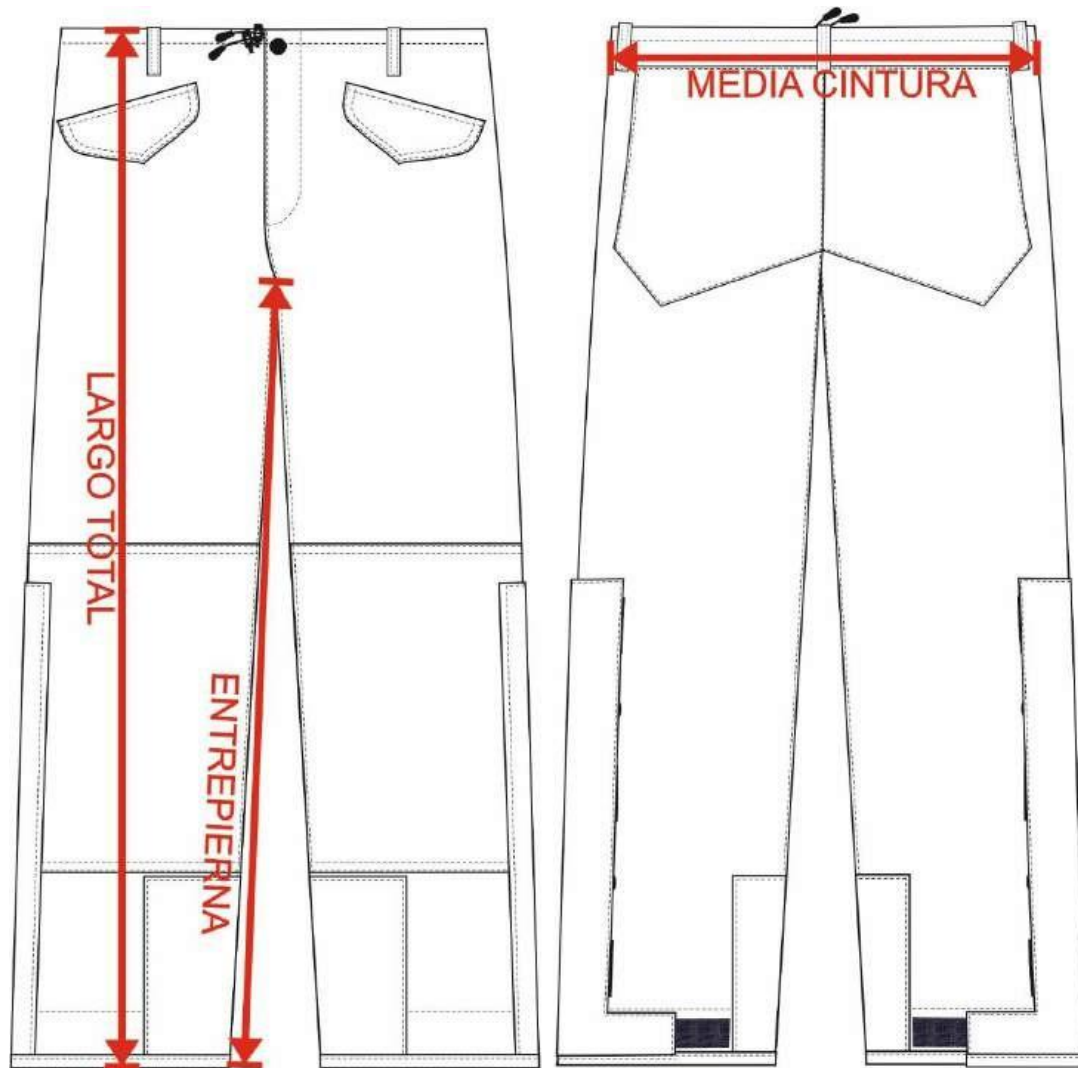

TALLE	LARGO TOTAL	ENTREPIERNA	MITAD CINTURA
S	106	70	54
M	106	70	56
L	111	80	58
XL	111	80	60
XXL	116	82	64

## CAMPERA PROTECCION CLIMATICA (MULTICAM)

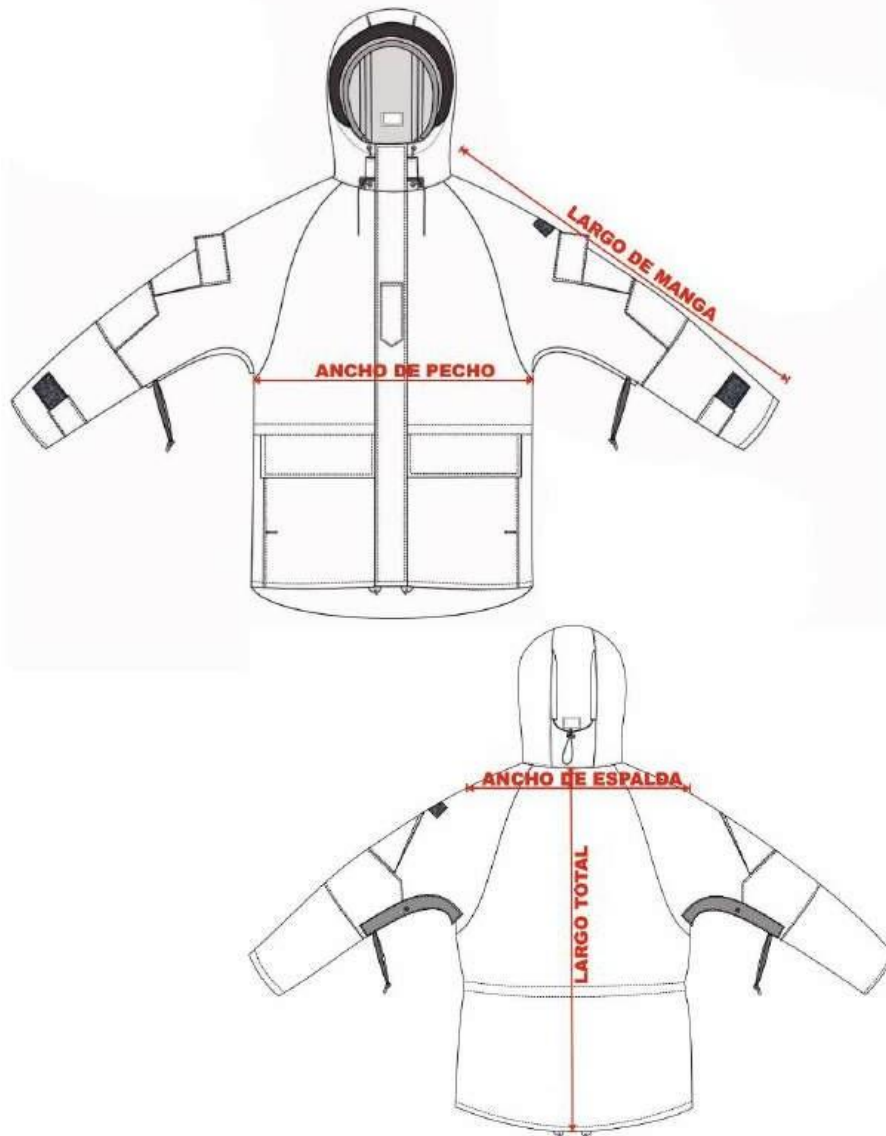

TALLE	ANCHO PECHO	ANCHO ESPALDA	LARGO TOTAL	LARGO MANGA
XS	54	40	81	78
S	58	44	83	79
M	62	48	85	80
L	66	52	87	81
XL	70	54	89	82
XXL	74	56	91	83

## PANTALON PROTECCION CLIMATICA (MULTICAM)

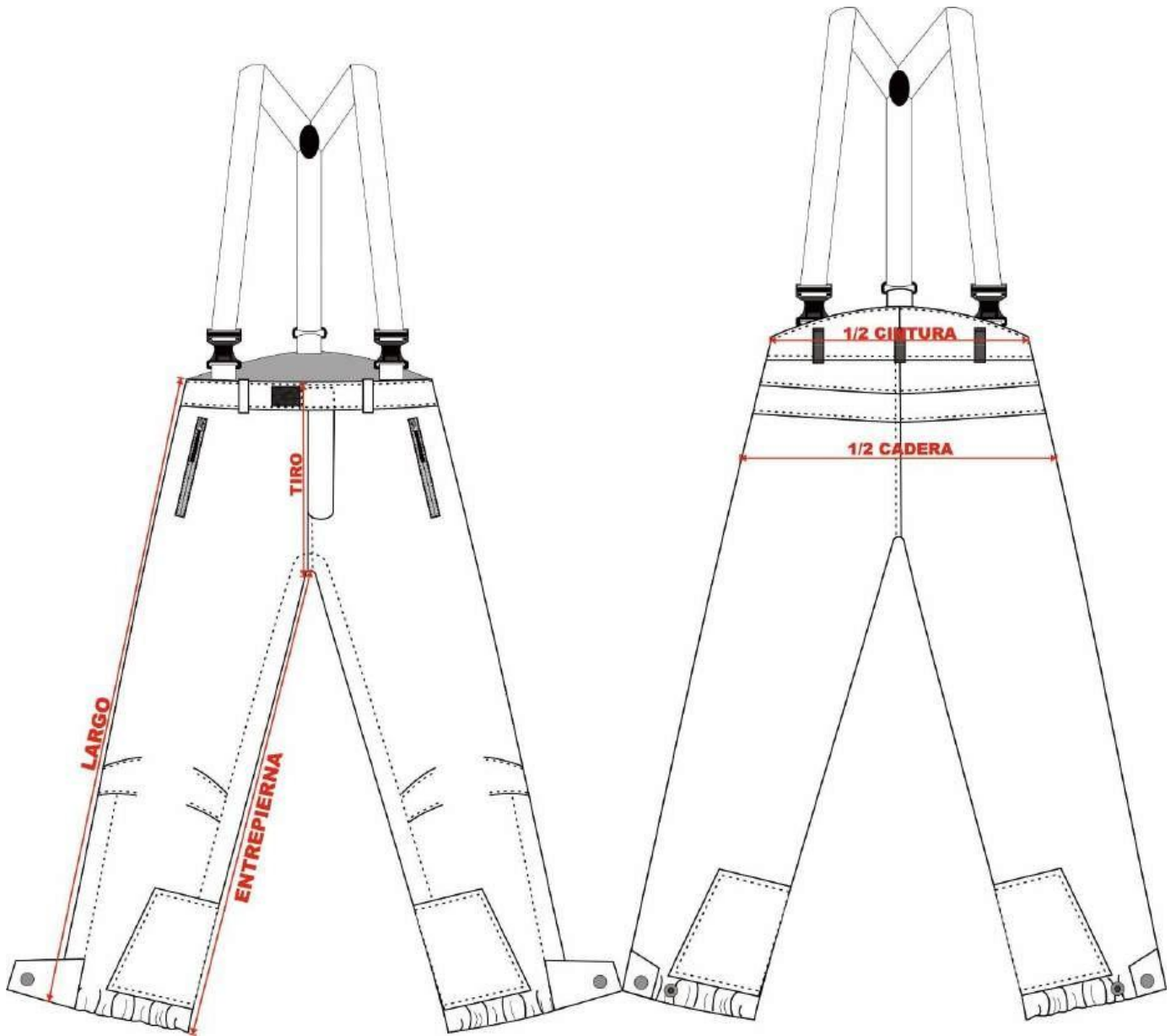

TALLE	LARGO	ENTREPIERNA	TIRO	1/2 CINTURA	1/2 CADERA
<b>XS</b>	97	72	34	38	48
<b>S</b>	101	74	36	41	52
<b>M</b>	105	77	38	46	56
<b>L</b>	109	79	40	50	60
<b>XL</b>	113	83	42	54	64
<b>XXL</b>	117	85	44	58	68

# CHAQUETA Y PANTALON MULTICAM

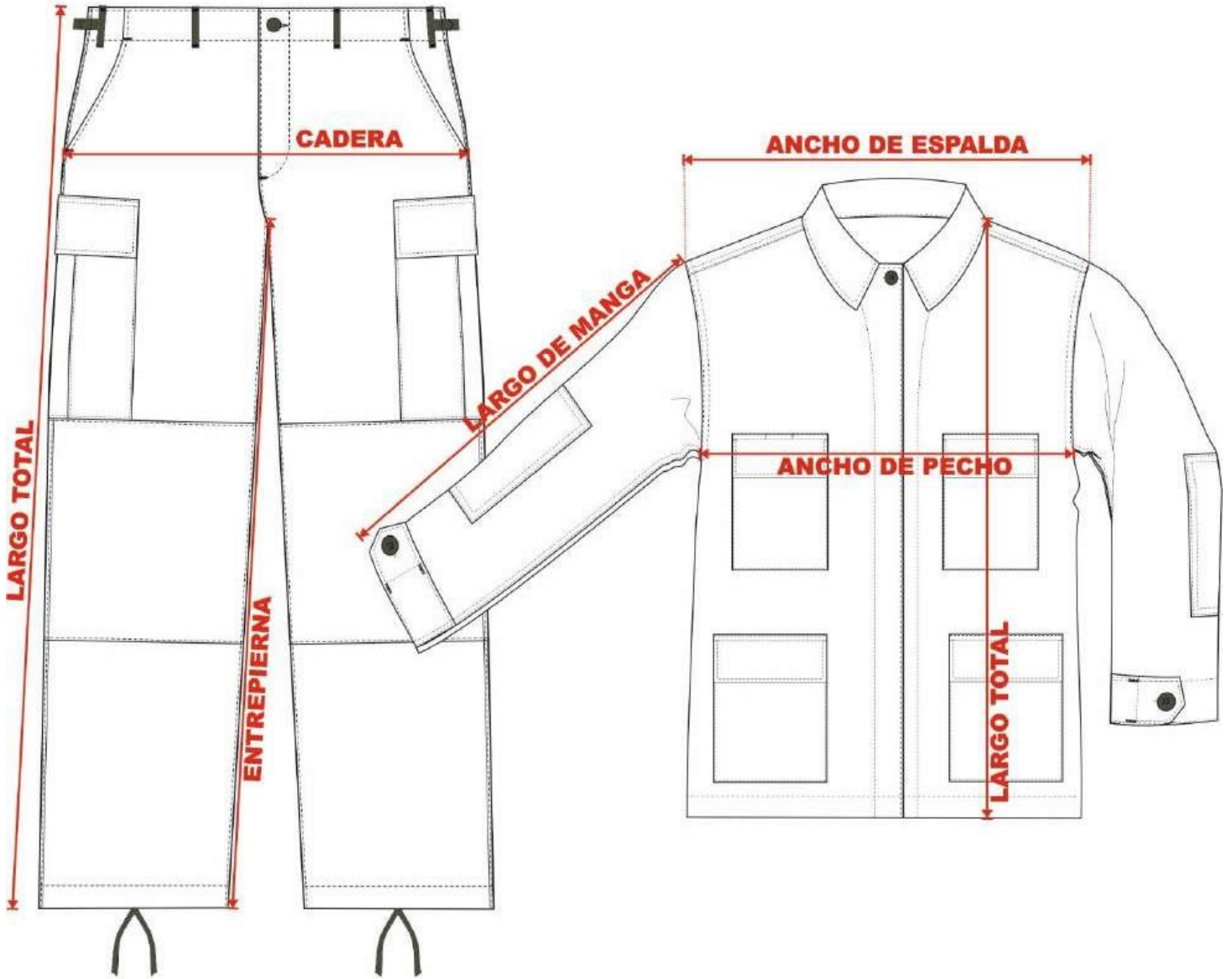

**CHAQUETA MULTICAM**

<b>TALLE</b>	<b>LARGO TOTAL</b>	<b>ANCHO ESPALDA</b>	<b>LARGO DE MANGA</b>	<b>ANCHO DE PECHO</b>
<b>S</b>	<b>76</b>	<b>46</b>	<b>63</b>	<b>58</b>
<b>M</b>	<b>78</b>	<b>48</b>	<b>64</b>	<b>61</b>
<b>L</b>	<b>80</b>	<b>50</b>	<b>65</b>	<b>64</b>
<b>XL</b>	<b>82</b>	<b>52</b>	<b>66</b>	<b>67</b>
<b>XXL</b>	<b>84</b>	<b>53</b>	<b>67</b>	<b>68</b>

**PANTALON MULTICAM**

<b>TALLE</b>	<b>LARGO TOTAL</b>	<b>ENTREPIERNA</b>	<b>CADERA</b>
<b>S</b>	<b>111</b>	<b>83</b>	<b>52</b>
<b>M</b>	<b>112</b>	<b>84</b>	<b>56</b>
<b>L</b>	<b>113</b>	<b>85</b>	<b>60</b>
<b>XL</b>	<b>114</b>	<b>86</b>	<b>64</b>
<b>XXL</b>	<b>114</b>	<b>87</b>	<b>68</b>

## CONJUNTO PARA DEPORTE AZUL ARA



## BUZO

TALLE	LARGO TOTAL	ANCHO DE PECHO	LARGO TOTAL MANGA	ANCHO CINTURA S/ESTIRAR	ANCHO CINTURA ESTIRADA
XS	54	47	71	29	46
S	56	49	71	29	46
	58	51	72	31	48
M	60	53	74	33	50
	62	55	76	35	52
L	64	57	78	37	53
	66	59	80	39	54
XL	68	61	82	41	56
	70	63	83	43	58
XXL	72	65	84	45	60
	74	67	84	47	62
XXXL	76	69	84	49	64

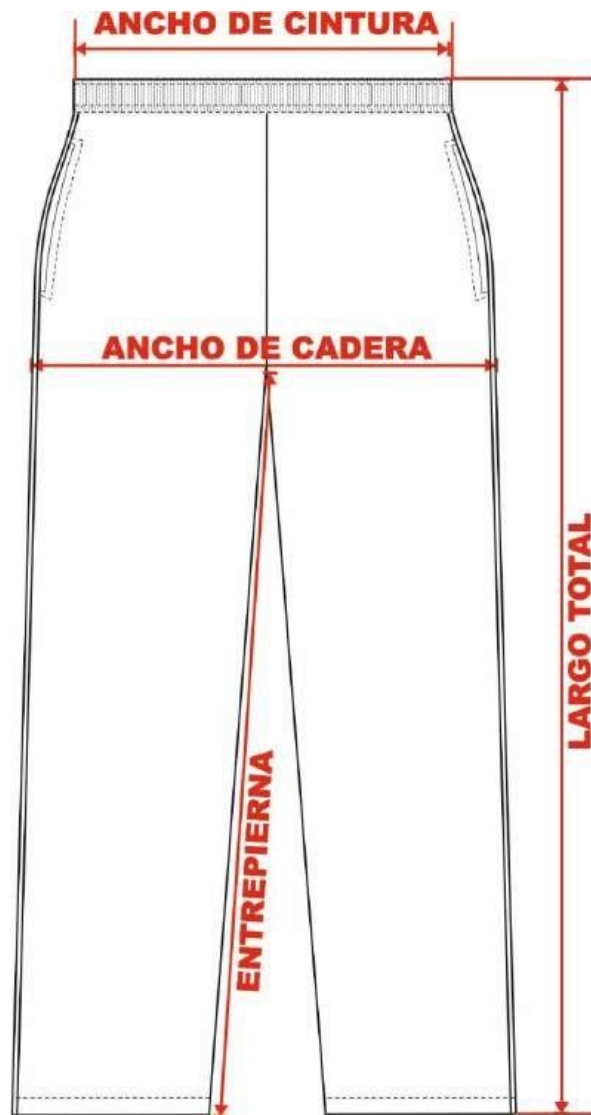

## PANTALON

TALLE	LARGO TOTAL	ENTREPIERNA	MEDIA CINTURA S/ESTIRAR	MEDIA CINTURA ESTIRADA	ANCHO CADERA
<b>XS</b>	<b>92-96-93</b>	<b>68</b>	<b>30</b>	<b>48</b>	<b>58</b>
<b>S</b>	<b>94-97-95</b>	<b>69</b>	<b>30</b>	<b>48</b>	<b>59</b>
	<b>96-98-97</b>	<b>70</b>	<b>31</b>	<b>50</b>	<b>60</b>
<b>M</b>	<b>98-99-99</b>	<b>71</b>	<b>32</b>	<b>52</b>	<b>61</b>
	<b>100-101-101</b>	<b>72</b>	<b>34</b>	<b>53</b>	<b>62</b>
<b>L</b>	<b>102-103-103</b>	<b>73</b>	<b>35</b>	<b>54</b>	<b>63</b>
	<b>104-105-105</b>	<b>74</b>	<b>36</b>	<b>55</b>	<b>64</b>
<b>XL</b>	<b>106-107-107</b>	<b>75</b>	<b>37</b>	<b>56</b>	<b>65</b>
	<b>108-109-109</b>	<b>76</b>	<b>38</b>	<b>58</b>	<b>66</b>
<b>XXL</b>	<b>110-111-111</b>	<b>77</b>	<b>39</b>	<b>59</b>	<b>67</b>
	<b>112-111-113</b>	<b>78</b>	<b>40</b>	<b>60</b>	<b>68</b>
<b>XXXL</b>	<b>114-112-115</b>	<b>79</b>	<b>41</b>	<b>62</b>	<b>69</b>

# DEPORTE INVIERNO

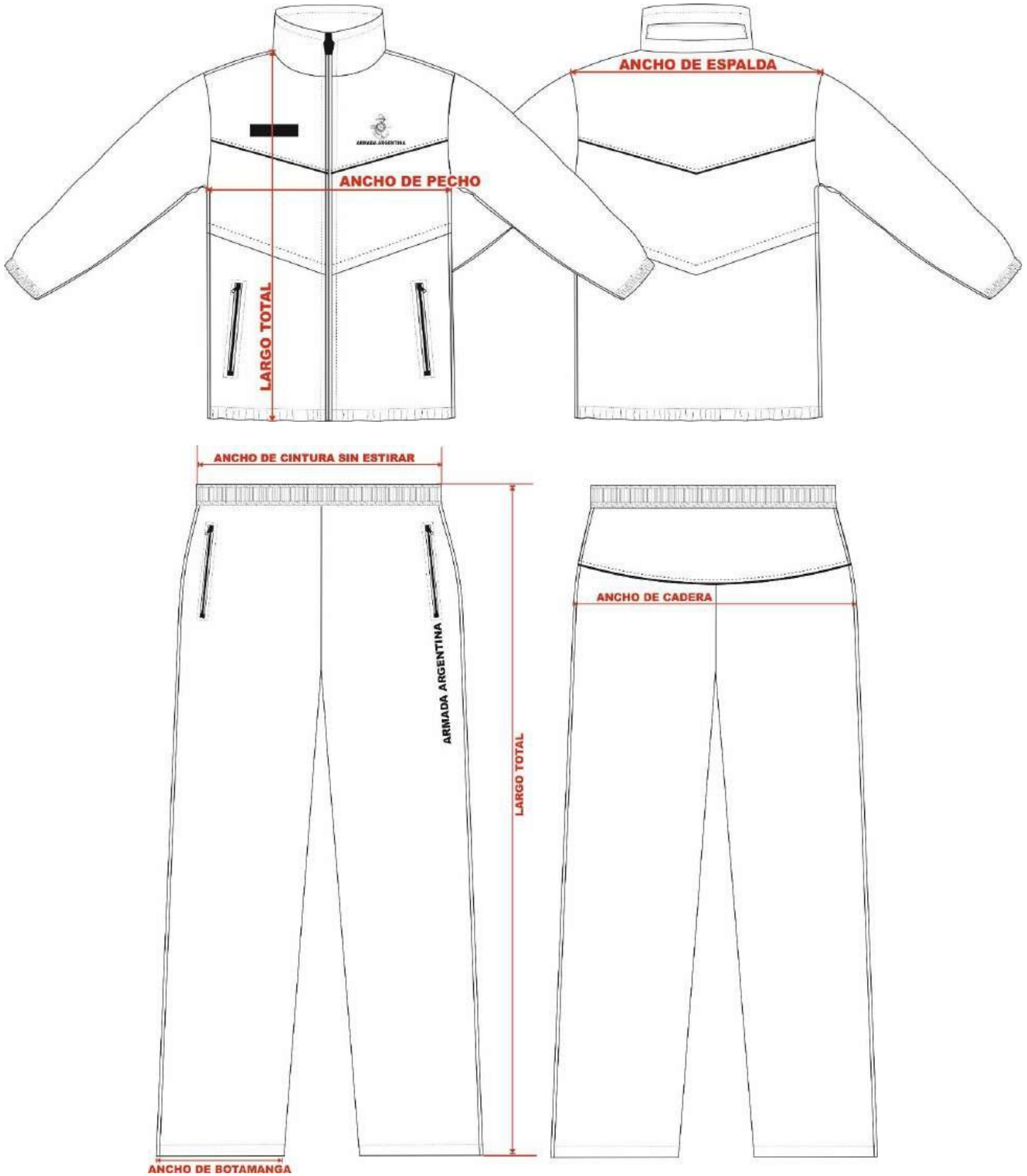

**CAMPERA**

<b>TALLE</b>		<b>ANCHO DE PECHO</b>	<b>ANCHO DE ESPALDA</b>	<b>LARGO TOTAL</b>
<b>XS</b>	<b>bajo</b>	<b>50</b>	<b>44</b>	<b>64</b>
	<b>alto</b>	<b>50</b>	<b>44</b>	<b>74</b>
<b>S</b>	<b>bajo</b>	<b>54</b>	<b>46</b>	<b>66</b>
	<b>alto</b>	<b>54</b>	<b>46</b>	<b>76</b>
<b>M</b>	<b>bajo</b>	<b>58</b>	<b>48</b>	<b>68</b>
	<b>alto</b>	<b>58</b>	<b>48</b>	<b>78</b>
<b>L</b>	<b>bajo</b>	<b>62</b>	<b>50</b>	<b>70</b>
	<b>alto</b>	<b>62</b>	<b>50</b>	<b>80</b>
<b>XL</b>	<b>bajo</b>	<b>66</b>	<b>52</b>	<b>72</b>
	<b>alto</b>	<b>66</b>	<b>52</b>	<b>82</b>
<b>XXL</b>	<b>bajo</b>	<b>70</b>	<b>54</b>	<b>74</b>
	<b>alto</b>	<b>70</b>	<b>54</b>	<b>84</b>

**PANTALON**

<b>TALLE</b>		<b>ANCHO DE CINTURA SIN ESTIRAR</b>	<b>ANCHO DE CADERA</b>	<b>LARGO TOTAL</b>	<b>ANCHO DE BOTAMANGA</b>
<b>XS</b>	<b>bajo</b>	<b>33</b>	<b>53</b>	<b>92</b>	<b>20</b>
	<b>alto</b>	<b>33</b>	<b>53</b>	<b>96</b>	<b>20</b>
<b>S</b>	<b>bajo</b>	<b>35</b>	<b>55</b>	<b>96</b>	<b>20</b>
	<b>alto</b>	<b>35</b>	<b>55</b>	<b>98</b>	<b>20</b>
<b>M</b>	<b>bajo</b>	<b>37</b>	<b>57</b>	<b>100</b>	<b>20</b>
	<b>alto</b>	<b>37</b>	<b>57</b>	<b>102</b>	<b>20</b>
<b>L</b>	<b>bajo</b>	<b>42</b>	<b>59</b>	<b>104</b>	<b>20</b>
	<b>alto</b>	<b>42</b>	<b>59</b>	<b>106</b>	<b>20</b>
<b>XL</b>	<b>bajo</b>	<b>45</b>	<b>61</b>	<b>108</b>	<b>20</b>
	<b>alto</b>	<b>45</b>	<b>61</b>	<b>110</b>	<b>20</b>
<b>XXL</b>	<b>bajo</b>	<b>48</b>	<b>63</b>	<b>112</b>	<b>20</b>
	<b>alto</b>	<b>48</b>	<b>63</b>	<b>114</b>	<b>20</b>

**CHAQUETA**



Talle	Tipo	Largo	contorno de pecho	½ ancho de espalda	Largo de manga
<b>XS</b>	BAJO	68	50	20	55
	MEDIO	70	50	20	58
	ALTO	72	50	20	60
<b>S</b>	BAJO	70	54	22	55
	MEDIO	72	54	22	58
	ALTO	74	54	22	60
<b>M</b>	BAJO	72	58	23	58
	MEDIO	74	58	23	60
	ALTO	78	58	23	62
<b>L</b>	BAJO	76	62	26	60
	MEDIO	78	62	26	62
	ALTO	82	62	26	64
<b>XL</b>	BAJO	78	66	28	62
	MEDIO	82	66	28	64
	ALTO	84	66	28	66
<b>XXL</b>	BAJO	80	72	31	64
	MEDIO	83	72	31	66
	ALTO	86	72	31	68

# CHAQUETA

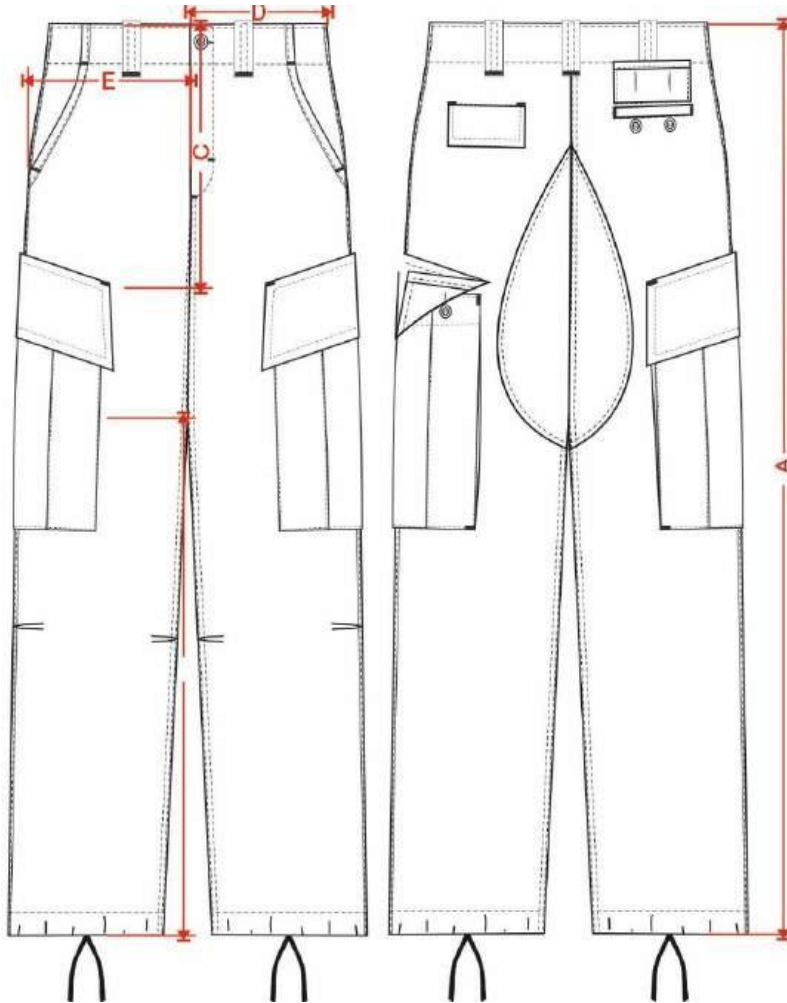

Talle	Tipo	Largo A	Entrepierna B	Tiro C	½ Cintura D	½ Cadera E
XS	BAJO	93	71	25	36	46
	MEDIO	96	72	26	36	46
	ALTO	100	74	27	36	46
S	BAJO	96	72	26	39	49
	MEDIO	100	74	27	39	49
	ALTO	104	77	29	39	49
M	BAJO	100	74	27	44	54
	MEDIO	104	77	29	44	54
	ALTO	108	79	31	44	54
L	BAJO	104	77	29	48	58
	MEDIO	108	79	31	48	58
	ALTO	112	83	33	48	58
XL	BAJO	108	80	31	52	62
	MEDIO	112	83	33	52	62
	ALTO	116	85	34	52	62
XXL	BAJO	108	80	33	56	66
	MEDIO	116	85	34	56	66
	ALTO	120	88	36	56	66

**CAMISETA PRIMERA PIEL (UCAN)**



TALLE	LARGO FRONTAL	LARGO TRASERO	ANCHO DE PECHO	ANCHO DE HOMBROS
XS	62	68	46	38
S	63	70	50	40
M	65	72	54	42
L	68	75	58	44
XL	70	77	62	46
XXL	72	79	66	48

## PANTALON PRIMERA PIEL (UCAN)

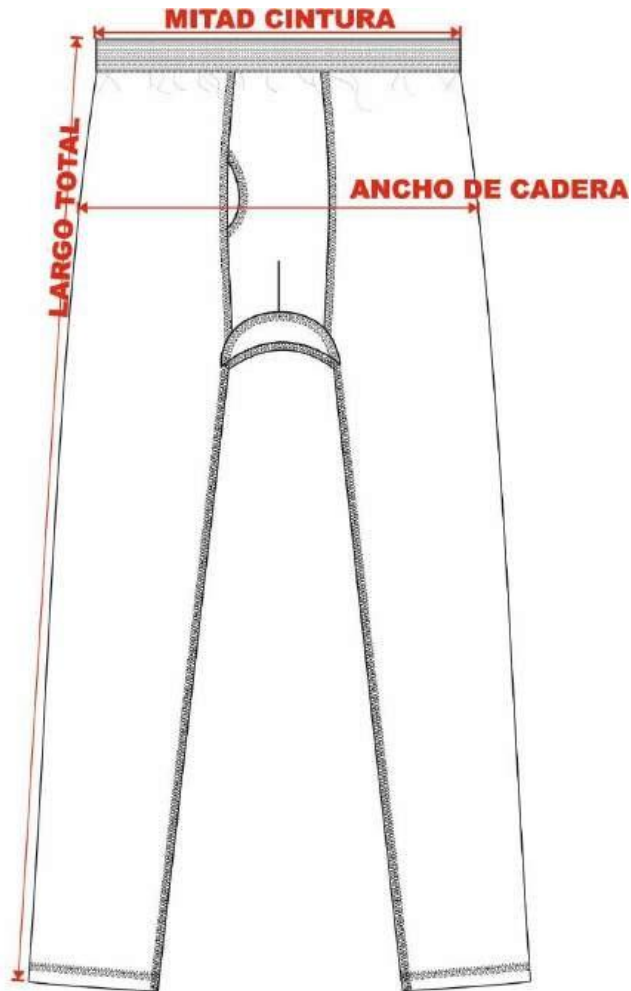

TALLE	LARGO TOTAL	ANCHO DE CADERA	MITAD CINTURA
<b>XS</b>	90	50	29
<b>S</b>	94	52	31
<b>M</b>	98	54	33
<b>L</b>	102	56	35
<b>XL</b>	106	58	37
<b>XXL</b>	110	60	39

## PRIMERA PIEL (COOLMAX) (UCA)



## CAMISETA (COOLMAX) (UCA)

TALLE	LARGO TOTAL	.MITAD CONT DE PECHO	LARGO MANGA PARTE SUPERIOR	LARGO MANGA PARTE INFERIOR
<b>XS</b>	<b>63</b>	<b>36</b>	<b>48</b>	<b>35</b>
<b>S</b>	<b>67</b>	<b>40</b>	<b>51</b>	<b>39</b>
<b>M</b>	<b>71</b>	<b>44</b>	<b>55</b>	<b>43</b>
<b>L</b>	<b>75</b>	<b>48</b>	<b>59</b>	<b>47</b>
<b>XL</b>	<b>79</b>	<b>52</b>	<b>63</b>	<b>51</b>
<b>XXL</b>	<b>82</b>	<b>58</b>	<b>69</b>	<b>57</b>
<b>XXXL</b>	<b>85</b>	<b>62</b>	<b>75</b>	<b>63</b>

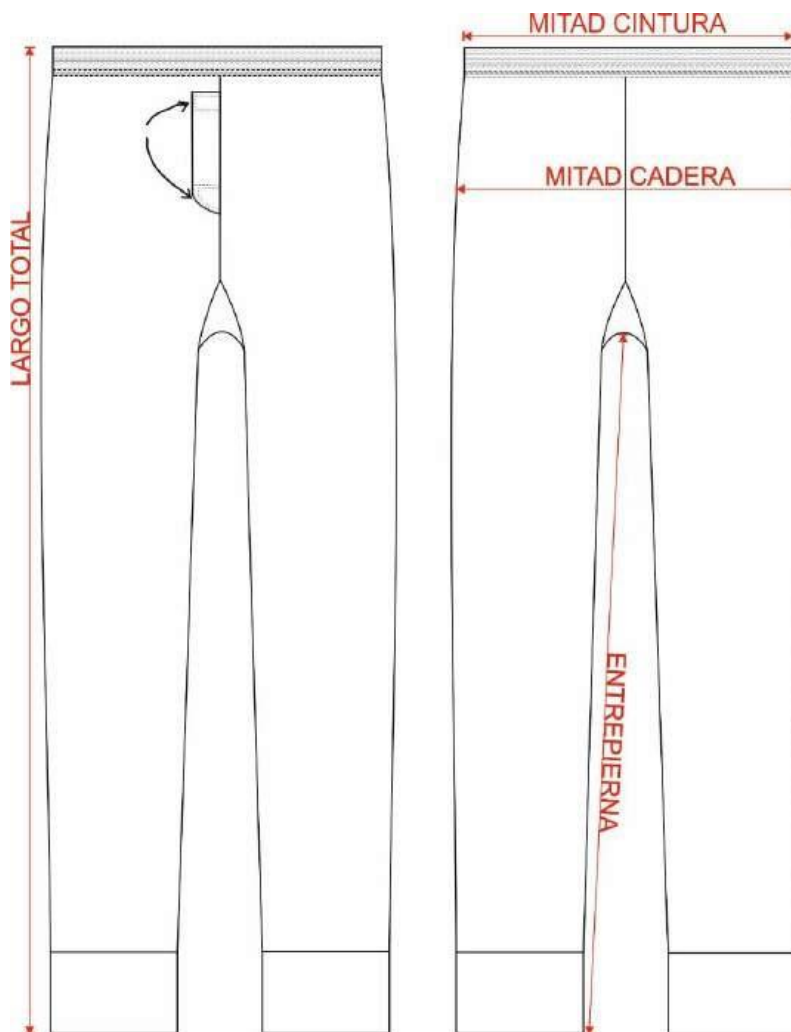

### PANTALON (COOLMAX) (UCA)

TALLE	LARGO TOTAL	MITAD CADERA	MITAD CINTURA ESTIRADA
<b>XS</b>	<b>98</b>	<b>38</b>	<b>38</b>
<b>S</b>	<b>100</b>	<b>40</b>	<b>40</b>
<b>M</b>	<b>102</b>	<b>42</b>	<b>42</b>
<b>L</b>	<b>104</b>	<b>44</b>	<b>44</b>
<b>XL</b>	<b>106</b>	<b>46</b>	<b>46</b>
<b>XXL</b>	<b>108</b>	<b>48</b>	<b>48</b>
<b>XXXL</b>	<b>110</b>	<b>50</b>	<b>50</b>

## GABAN AZUL

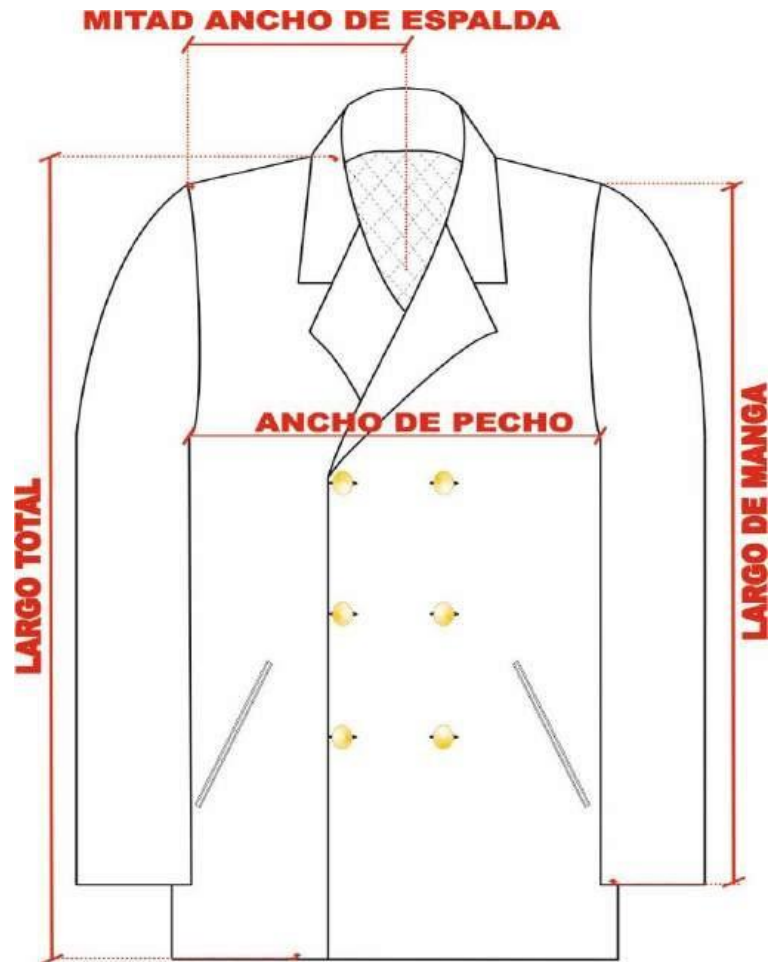

TALLE		LARGO TOTAL	MITAD ANCHO DE ESPALDA	LARGO DE MANGA	ANCHO DE PECHO
40	L	76	19,5	58	40
	M	80	19,5	61	40
	C	84	19,5	64	40
42	L	76	20	58	42
	M	80	20	61	42
	C	84	20	64	42
44	L	76	20,5	58	44
	M	80	20,5	61	44

	<b>C</b>	<b>84</b>	<b>20,5</b>	<b>64</b>	<b>44</b>
<b>46</b>	<b>L</b>	<b>76</b>	<b>21</b>	<b>59</b>	<b>45</b>
	<b>M</b>	<b>80</b>	<b>21</b>	<b>62</b>	<b>45</b>
	<b>C</b>	<b>84</b>	<b>21</b>	<b>65</b>	<b>45</b>
<b>48</b>	<b>L</b>	<b>76</b>	<b>22</b>	<b>59</b>	<b>46</b>
	<b>M</b>	<b>80</b>	<b>22</b>	<b>62</b>	<b>46</b>
	<b>C</b>	<b>84</b>	<b>22</b>	<b>65</b>	<b>46</b>
<b>50</b>	<b>L</b>	<b>76</b>	<b>22,5</b>	<b>59</b>	<b>48</b>
	<b>M</b>	<b>80</b>	<b>22,5</b>	<b>62</b>	<b>48</b>
	<b>C</b>	<b>84</b>	<b>22,5</b>	<b>65</b>	<b>48</b>
<b>52</b>	<b>L</b>	<b>76</b>	<b>23,5</b>	<b>60</b>	<b>50</b>
	<b>M</b>	<b>80</b>	<b>23,5</b>	<b>63</b>	<b>50</b>
	<b>C</b>	<b>84</b>	<b>23,5</b>	<b>66</b>	<b>50</b>
<b>54</b>	<b>L</b>	<b>77</b>	<b>24</b>	<b>60</b>	<b>52</b>
	<b>M</b>	<b>81</b>	<b>24</b>	<b>63</b>	<b>52</b>
	<b>C</b>	<b>85</b>	<b>24</b>	<b>66</b>	<b>52</b>
<b>56</b>	<b>L</b>	<b>77</b>	<b>24,5</b>	<b>60</b>	<b>55</b>
	<b>M</b>	<b>81</b>	<b>24,5</b>	<b>63</b>	<b>55</b>
	<b>C</b>	<b>85</b>	<b>24,5</b>	<b>66</b>	<b>55</b>
<b>58</b>	<b>L</b>	<b>77</b>	<b>25</b>	<b>61</b>	<b>57</b>
	<b>M</b>	<b>81</b>	<b>25</b>	<b>64</b>	<b>57</b>
	<b>C</b>	<b>85</b>	<b>25</b>	<b>67</b>	<b>57</b>
<b>60</b>	<b>L</b>	<b>77</b>	<b>25,5</b>	<b>61</b>	<b>59</b>
	<b>M</b>	<b>81</b>	<b>25,5</b>	<b>64</b>	<b>59</b>
	<b>C</b>	<b>85</b>	<b>25,5</b>	<b>67</b>	<b>59</b>

## MAMELUCO IMPERMEABLE

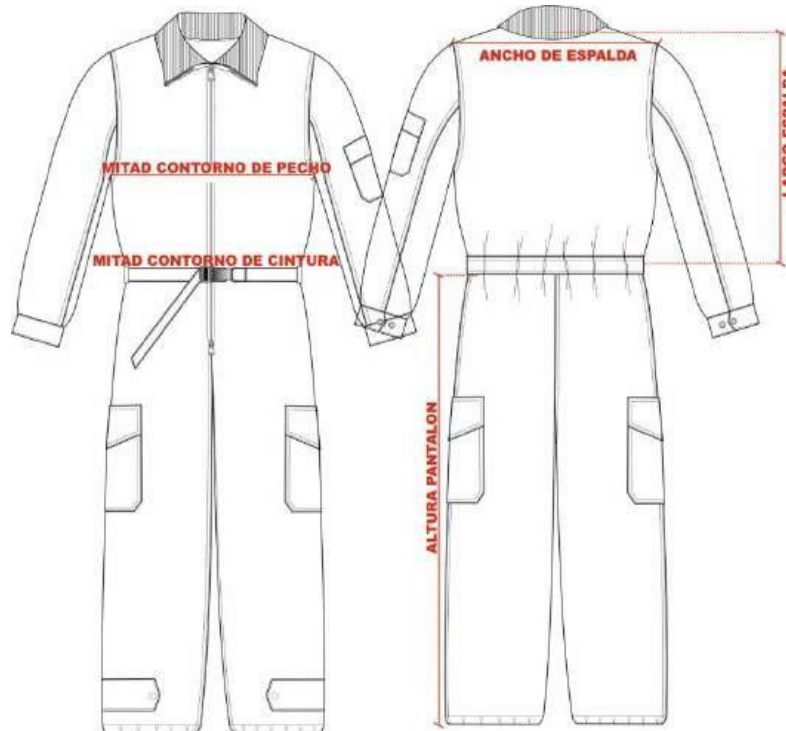

TALLE	LARGO SUPERIOR ESPALDA	MITAD CONTORNO PECHO	ANCHO ESPALDA	MITAD CONTORNO CINTURA	LARGO PANTALÓN
42	47	54	44	48	100
44	47	56	46	50	102
46	49	58	48	52	102
48	49	60	50	54	103
50	50	62	52	56	103
52	51	64	54	58	103
54	52	66	56	60	104
56	53	68	58	62	104
58	54	70	60	64	105
60	54	72	62	66	106
62	54	74	64	68	107

## MAMELUCO AZUL NEGRO DE RIPSTOP

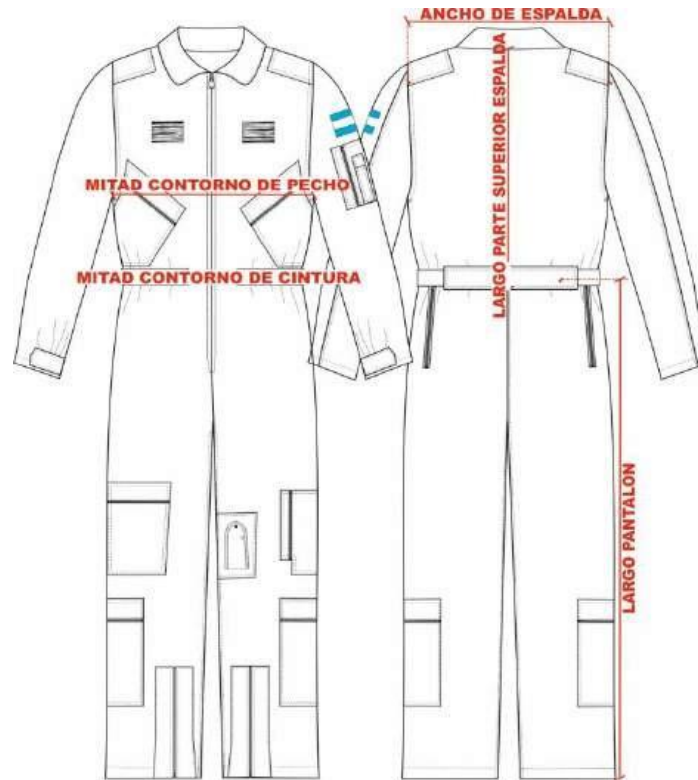

## MAMELUCO RIPSTOP

TALLE	LARGO PARTE SUPERIOR	MITAD DE ESPALDA	LARGO DE PANTALÓN	MITAD DE CINTURA	MITAD DE CADERA
42	46	21	102	43	48
44	46	22	102	44	50
46	46	23	102	46	52
48	48	24	104	48	54
50	50	24 1/2	104	50	56
52	50	25	104	52	58
54	50	25 1/2	104	54	60
56	52	26	107	56	62
58	52	26 1/2	107	58	64
60	52	27	107	60	66

SECTOR ESPECIFICACIONES TECNICAS

## MAMELUCO CUELLO TIPO CAMISA USO DIARIO

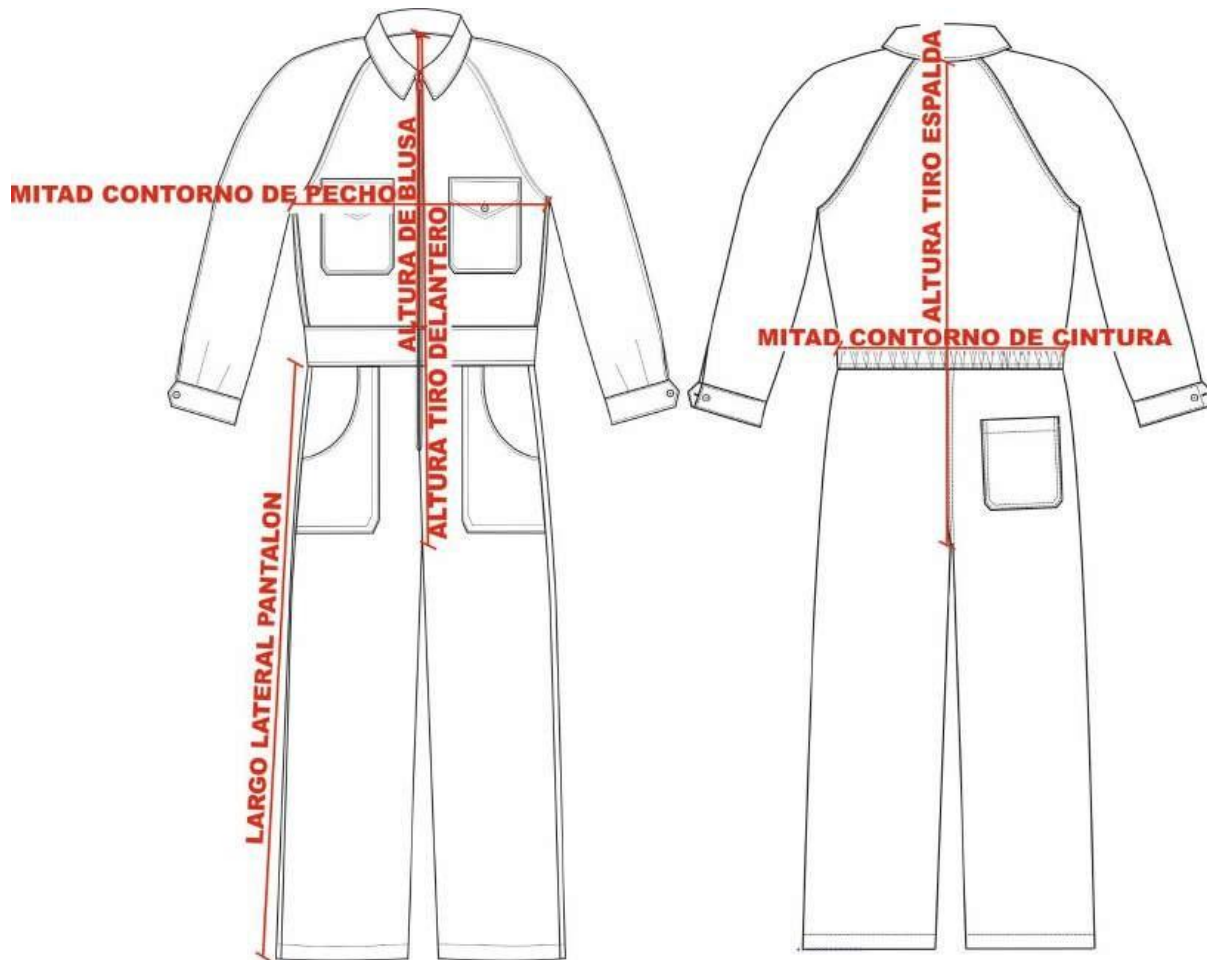

TALLE	ALTURA DE BLUSA	MITAD CONTORNO DE PECHO	MITAD CONTORNO DE CINTURA	LARGO LATERAL PANTALON	ALTURA TIRO DELANTERO	ALTURA TIRO ESPALDA
44	48	56	51	108	71,5	93
46	48,5	58	53	108,5	73	94,5
48	49	60	55	109	74,5	96
50	49,5	62	57	109,5	76	97,5
52	50	64	60	110	77,5	99
54	50,5	66	63	110,5	79	100,5
56	51	68	66	111	80,5	102

## SWEATER



TALLE	ANCHO DE PECHO	ANCHO DE ESPALDA	LARGO TOTAL	LARGO DE MANGA
XS	45	41	58	52
S	49	44	63	56
M	53	47	67	60
L	57	50	71	63
XL	60	53	73	65
XXL	63	56	75	67
XXXL	66	59	77	69

## GALERA, GORRA Y GORRO

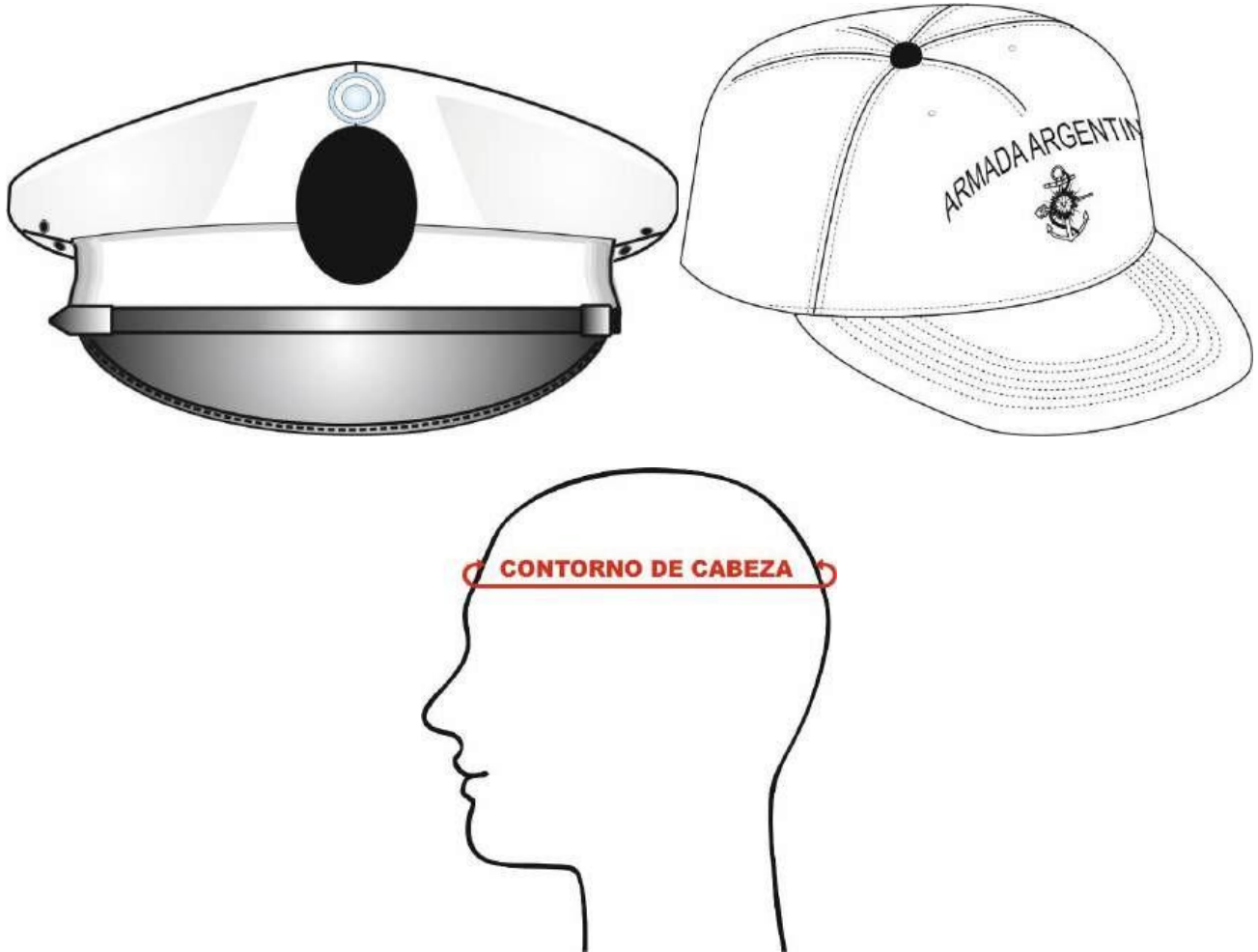

## DETERMINACION DEL TAMAÑO

TAMAÑO	PERÍMETRO DE LA CABEZA (CM)
53	53
54	54
55	55
56	56
57	57
58	58

## JARDINERO COLOR AZUL NEGRO PARA EMBARAZADAS

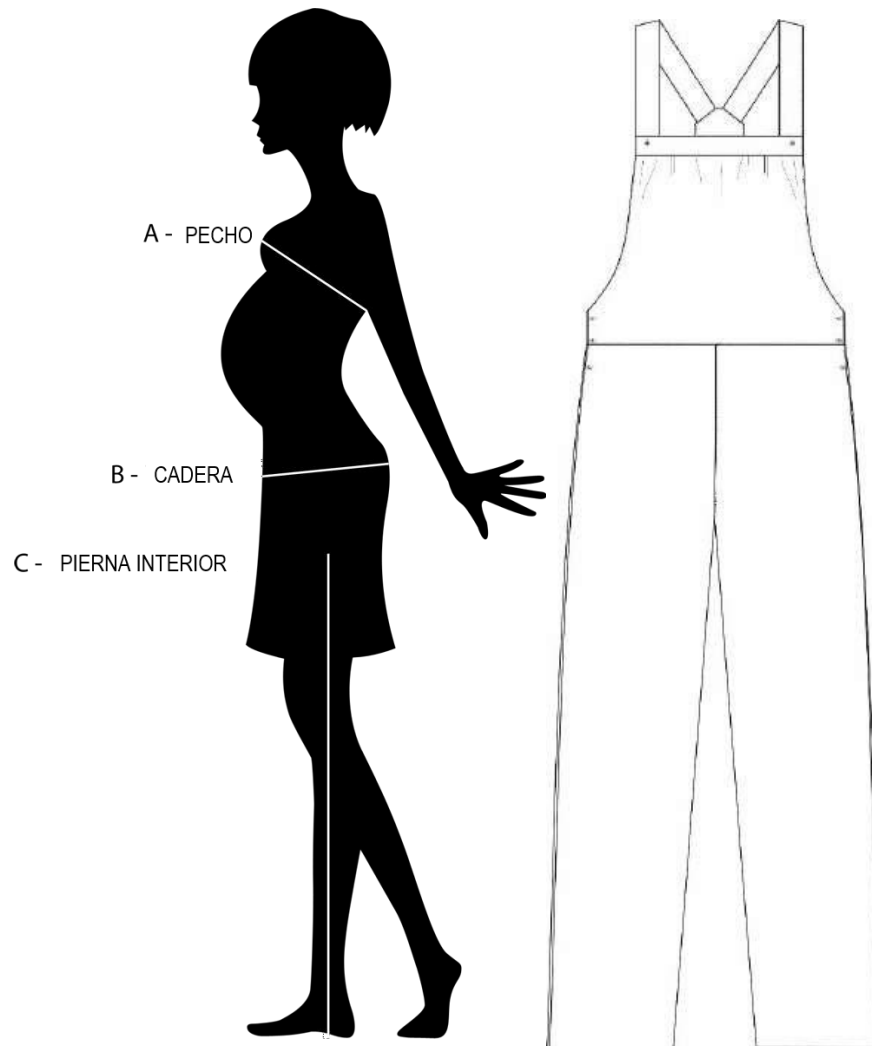

**A) - PECHO ES LA MEDIDA DE LA CIRCUNFERENCIA DEL BUSTO DEBAJO DE SUS BRAZOS MIENTRAS USA SU SOSTÉN.**

**B) - CADERA MIDA LA CIRCUNFERENCIA DE SU CADERA EN SU PARTE MÁS ANCHA.**

**C) - PIERNA INTERIOR ES LA MEDIDA QUE VA DE LA ENTREPIERNA AL SUELO, DESCALZA.**

TALLE	A-PECHO	B-CADERA	C-PIERNA INTERIOR
<b>M</b>	<b>85-100</b>	<b>95-100</b>	<b>84</b>
<b>L</b>	<b>105-110</b>	<b>100-105</b>	<b>84</b>
<b>XL</b>	<b>115-120</b>	<b>105-108</b>	<b>84</b>
<b>XXL</b>	<b>120 a mas</b>	<b>108 - 112</b>	<b>84</b>

## MEDIAS POLIVALENTES (UCAN) BLANCAS DE ALGODÓN Y MEDIAS TERMICAS

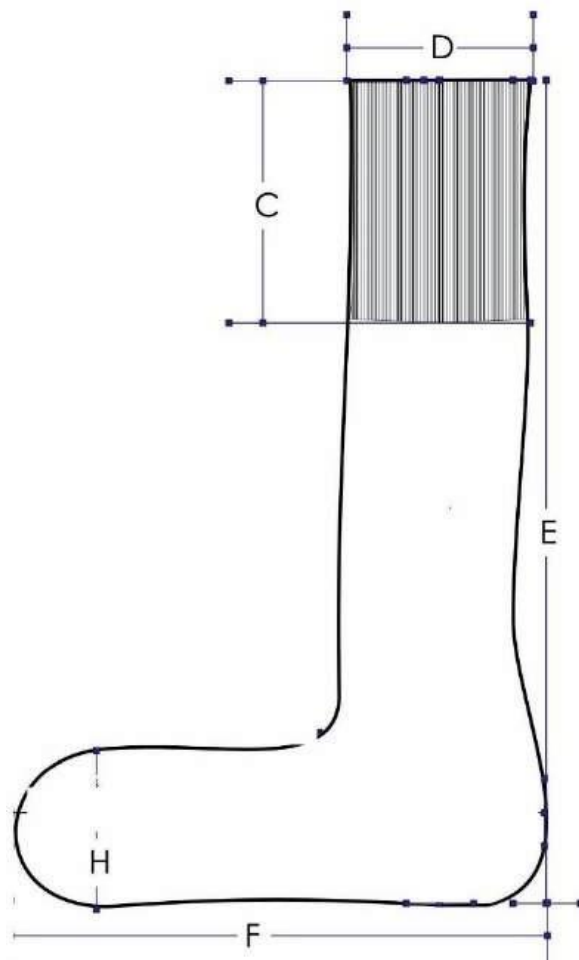

TAMAÑO	ANCHO DE PIE (H)		ANCHO DE PUÑO (D)		LARGO DE PIE (F)		LARGO DE CAÑA + PUÑO (E)		ALTO DE PUÑO (C)	
	Mín	Máx	Mín	Máx	Mín	Máx	Mín	Máx	Mín	Máx
<b>1</b>	8	10	7	10	22,5	24,5	37	40	7	9
<b>2</b>	8	10	7	10	23,5	25,5	38	41	7	9
<b>3</b>	8	10	7	10	24,5	26,5	39	42	7	9
<b>4</b>	8	10	7	10	25,5	28	40	43	7	9

## PANTALON CORTO DE SARGA



TALLE	LARGO TOTAL	MITAD CADERA	MITAD CINTURA S/ESTIRAR
40	29	46	34
42	30.5	48	36
44	31	50	37
46	32	52	39
48	33	54	40
50	34	56	42
52	35	58	43
54	37	60	45
56	38	62	46
58	39	64	48